

gear

TECHNOLOGY®

MAR/APR
2022

METALS AND METALLURGY

- * LOW PRESSURE CARBURIZING
- * HARDNESS TESTING
- * BRONZE GEAR BLANKS

Spiral
Bevel
Gears



www.geartechnology.com

See our ad

P.57



Expanding Your Precision into Smaller Applications



Phone: 847-649-1450 | www.star-su.com
5200 Prairie Stone Pkwy. | Ste. 100 | Hoffman Estates | IL 60192

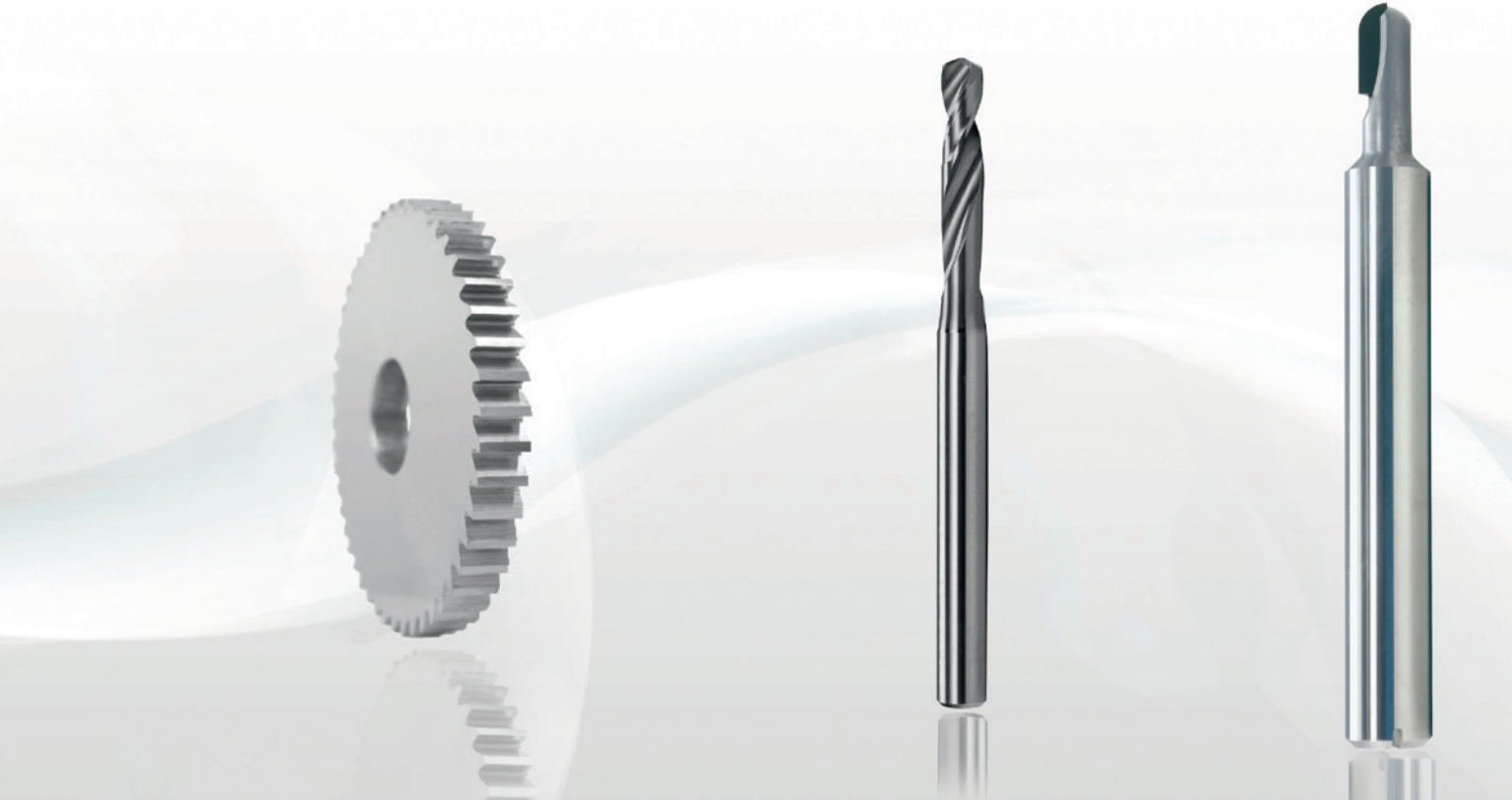

Star SU Partners with Louis Bélet Swiss Cutting Tools

We've added Louis Belet to our offering, bringing you even more capability for precision applications. Based in Swiss Jura, the hub of micromechanics and high-quality precision, Louis Bélet manufactures standard and custom precision cutting tools for various markets including watchmaking, medical, aerospace and automotive. Its suite of tools includes drills, end mills, thread and gear cutting tools including hobs or skiving tools for micro gears, and more.

This innovative offering, combined with Star SU's existing portfolio and market presence, enables us to offer you the highest quality micro cutting tools for your precision applications.





A Publication of
The American Gear
Manufacturers Association

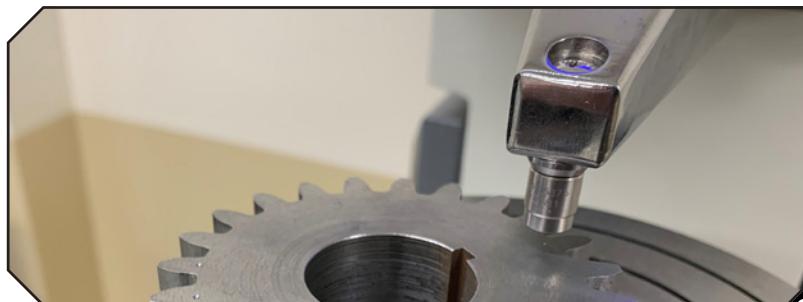

26

features

- 20** **LPC Carburizing: The Affordable Alternative to Gas Carburizing**
Low pressure carburizing isn't just for aerospace.
- 26** **Hardness Testing Gears — Know Your Options for Best Results**
The basics of Rockwell, Brinell and Vickers/Knoop.
- 30** **Kapp Niles Examines Intelligent Rolling Grinding for E-mobility**
Generating grinding takes on noise for the latest automotive applications.
- 34** **The New Age of Bronze**
Supply chain constraints and fast-rising commodity prices are taking their toll. Here's how one Midwest producer of bronze gear blanks is helping gear manufacturers "re-shore" —and shorten the distance from bronze blank to finished gear.
- 42** **Arvin's Angle**
Relationship Building—The Critical Component of Success.

technical

- 45** **Tooth Root Bending Strength of Shot-Peened Gears Made of High-Purity Steels up to the VHCF Range.**

The load capacity calculation for gears according to standardized methods, like AGMA 2001-D04 or ISO 6336, are intentionally conservative to ensure broad applicability in industrial practice. However, due to new applications and higher requirements, more detailed design calculations and higher tooth flank and tooth root load carrying capacities up to the very high cycle fatigue (VHCF) range are nowadays often necessary.



45

Stay Connected



Join the Gear Technology Facebook group at
www.facebook.com/help/312721188838183



Follow us on Twitter
twitter.com/Gear_Technology



Connect with us on LinkedIn
www.linkedin.com/groups/3893880/

Subscribe Online
www.geartechnology.com/subscribe.htm



Vol. 39, No. 2 GEAR TECHNOLOGY. The Journal of Gear Manufacturing (ISSN 0743-6858) is published monthly, except in February, April, October and December by The American Gear Manufacturers Association, 1840 Jarvis Avenue, Elk Grove Village, IL 60007, (847) 437-6604. Cover price \$7.00 U.S. Periodical postage paid at Arlington Heights, IL, and at additional mailing office (USPS No. 749-290). The American Gear Manufacturers Association makes every effort to ensure that the processes described in GEAR TECHNOLOGY conform to sound engineering practice. Neither the authors nor the publisher can be held responsible for injuries sustained while following the procedures described. Postmaster: Send address changes to GEAR TECHNOLOGY. The Journal of Gear Manufacturing, 1840 Jarvis Avenue, Elk Grove Village, IL, 60007. Contents copyrighted ©2022 by THE AMERICAN GEAR MANUFACTURERS ASSOCIATION. No part of this publication may be reproduced or transmitted in any form or by any means, electronic or mechanical, including photocopying, recording, or by any information storage and retrieval system, without permission in writing from the publisher. Contents of ads are subject to Publisher's approval. Canadian Agreement No. 40038760.



PRÄWEMA SynchroForm V

Hard-fine machining of components with internal gearing

The modular machine for geared drive components

▣ COMPLETE PROCESSING FOR YOUR GEARS

Skiving or gear honing of internal or external gears combined with further technologies like deburring, turning, as well as hard turning or grinding to achieve best workpiece qualities.

▣ SINGEL OR DOUBLE SPINDLE AVAILABLE

Set up as a single or twin spindle machine, it excels in series production with extremely profitable cycle times and high-precision machining results.

▣ DRESSABLE TOOLS FOR INTERNAL HONING

Regrinding service in original quality for Skiving tools. Optimized tool design for subsequent hard machining PräwemaHoning. Dressable tools for internal honing to optimize tool costs. High flexibility for gear data corrections with PRÄWEMA Dressing tool VSDi®.



Vacuum Heat Treating Services

We know high quality gears and components are vital to performance. Our leading edge vacuum technology and expertise provides precise control and repeatability for consistently superior parts.

- Low Pressure Carburizing (LPC)
- Vacuum Gas Nitriding
- Vacuum Stress Relieving
- High Pressure Gas Quenching (HPGQ)

Advantages

- Uniformity of case depths
- Minimized distortion
- No IGO (Intergranular Oxidation)
- Parts returned clean, free of soot – eliminating downstream cleaning processes

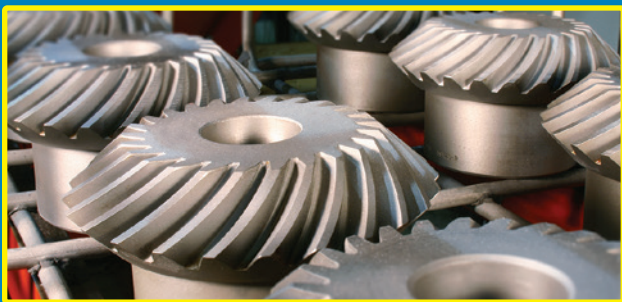

SOLAR
ATMOSPHERES
1-855-WE-HEAT-IT
solaratm.com

Nadcap
Administered by PRO
ACCREDITED
HEAT TREATING
NONDESTRUCTIVE TESTING
AS 9001:2015
AS 9100D
registered

Eastern PA • Western PA • California • South Carolina

gear

TECHNOLOGY® Vol. 39, No. 2

departments

- 06 GT Extras**
Romax virtual prototyping, QuesTek's Ferrium C64 for Additive Manufacturing and Eurotrans Gear Week.
- 08 Publisher's Page**
Knowledge AND Connections.
- 10 Product News**
Liebherr skiving technology; Junker grinding machines; gear shaping with Helios Gear Products; cutting gear teeth with EMAG SU.
- 40 Tech Talk**
High-Speed Invitation.
- 56 Industry News**
Klingelberg reports on assembly hall project; Star SU and Louis Bélet enter strategic partnership; C & B Machinery announces partnership with PTG—Holroyd.
- 61 Calendar**
May 17–19: Fundamentals of Parallel Axis Gear Manufacturing, Elgin, Ill.; May 17–19: GrindingHub 2022, Stuttgart, Germany; May 18–19: CTI Symposium USA, Novi, Mich.
- 62 Advertiser Index**
Contact information for companies in this issue.
- 64 Addendum**
Light, Movement, Perspective, LEGO!



THE DREAM MACHINE

Fast, Grind-Quality Horizontal Hobbing

The machines you've always dreamed of...

The HAMAI series of worldclass horizontal hobbers, combining high-speed, grinding-level precision with remarkable affordability. Leave it to MTB to bring the HAMAI lineup to North America.

It's the perfect fit: Japanese performance, craftsmanship and affordability; coupled with the American ingenuity and renowned expertise of MTB. We're like the OEM, only closer.

Ready for your HAMAI? **Contact MTB today.**



HAMAI
N-SERIES

- 7-Axis, 6,000 RPM; Grind Quality Results
- Shaft Lengths to 350/500 mm (Extended Travel)
- Machine Wet or Dry; Skiving Option
- Compact Design; Turnkey Automation Packages

HAMAI
TOKYO JAPAN



BURRI
WERKZEUGMASCHINEN



Machine Tool Builders
REBUILDING • RECONTROLLING • SERVICE

machinetoolbuilders.com
(815) 636-7502

**THE GEAR INDUSTRY'S
INFORMATION SOURCE**

www.geartechnology.com

GT Revolutions

The Role of Virtual Prototyping in Gear System Design and Manufacturing for E-mobility

NVH is a key metric in drive-system development for e-mobility. Careful design and manufacturing of gears are crucial to minimizing NVH, as tolerance variations can result in large differences between nominally identical components. Learn more here:

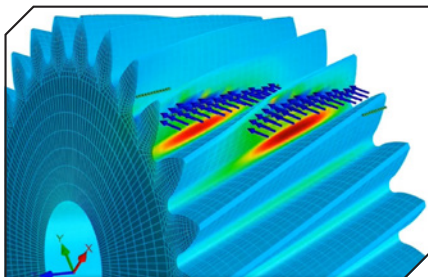

www.geartechnology.com/blogs/4-revolutions/post/29799-the-role-of-virtual-prototyping-in-gear-system-design-and-manufacturing-for-e-mobility

The Evolution of QuesTek's Ferrium C64 for Additive Manufacturing



Applying their Materials by Design methodologies, QuesTek Innovations has expanded their ICME framework under US Army Small Business Innovation Research (SBIR) funding to adapt their high-performance Ferrium C64 gear steel to AM processes to demonstrate printability across multiple systems, achieve AMS minimum tensile properties, and observe a positive response to heat treatment. Learn more here:

www.geartechnology.com/blogs/4-revolutions/post/29795-ferrium-c64-for-additive-manufacturing

Events

Eurotrans Gear Weeks 2022

Eurotrans Gear Training will be held online with live online presentations by top industry experts – three weeks packed with specialized gear design training. This comprehensive online course has been developed by Eurotrans, the European Committee for Power Transmission Engineering, in cooperation with FVA Software & Service, and leading gear experts from Germany. Learn more here:



www.geartechnology.com/events/5016-eurotrans-gear-weeks-2022

gear
TECHNOLOGY®



AGMA MEDIA
1840 JARVIS AVENUE
ELK GROVE VILLAGE, IL 60007
(847) 437-6604
FAX: (847) 437-6618

EDITORIAL

Publisher & Editor-in-Chief

Randy Stott, Vice President Media
stott@agma.org

Senior Editor

Matthew Jaster
jaster@agma.org

Senior Editor

Aaron Fagan
fagan@agma.org

Technical Editors

William (Bill) Bradley, Robert Errichello, John Lange, Joseph Mihelick, Charles D. Schultz, P.E., Robert E. Smith, Mike Tennutti, Frank Uherek

DESIGN

Art Director

David Ropinski
ropinski@agma.org

ADVERTISING

Associate Publisher & Advertising Sales Manager

Dave Friedman
friedman@agma.org

Materials Coordinator

Dorothy Fiandaca
fiandaca@agma.org

CIRCULATION

Circulation Manager

Carol Tratar
tratar@agma.org

ACCOUNTING

Accounting

Luann Harrold
harrold@agma.org

MANAGEMENT

President

Matthew E. Croson
croson@agma.org

FOUNDER

Michael Goldstein founded Gear Technology in 1984 and served as Publisher and Editor-in-Chief from 1984 through 2019. Thanks to his efforts, the Michael Goldstein Gear Technology Library, the largest collection of gear knowledge available anywhere, will remain a free and open resource for the gear industry. More than 36 years' worth of technical articles can be found online at www.geartechnology.com. Michael continues working with the magazine in a consulting role and can be reached via e-mail at michael@geartechnology.com.

ATLASBRONZE

All Bearings are not Round...



Look to us for all your Bronze Wear Plate needs!

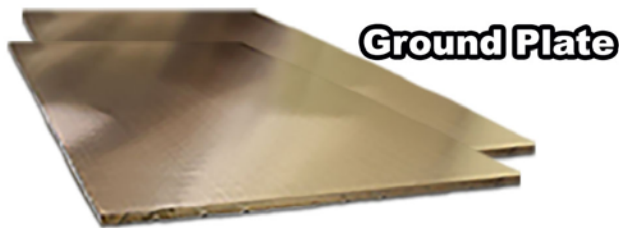

Ground Plate

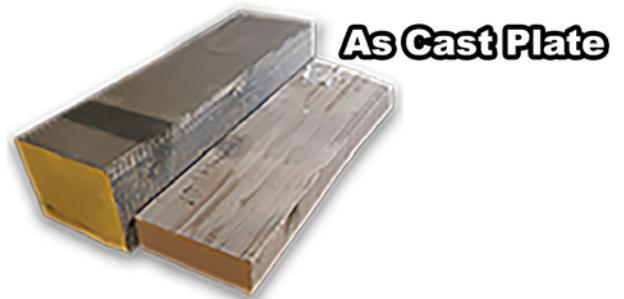

As Cast Plate

**Oversized
Saw Cut Plate**

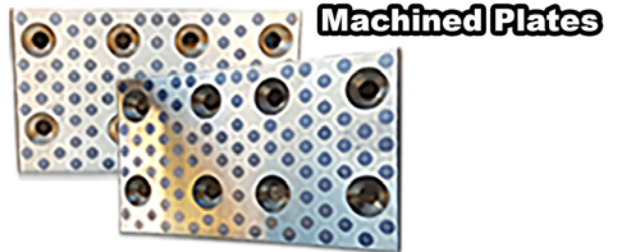
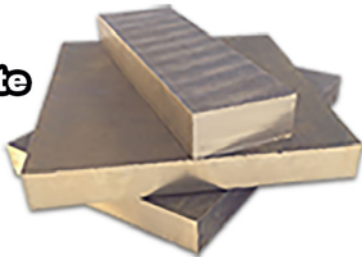

Machined Plates

We offer a wide selection of Stocked Bronze products and Made to Order/Engineered Parts



**Bronze
Bar Stock**

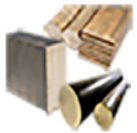

**Cast & Wrought
Alloys**



**Standard
Plate**

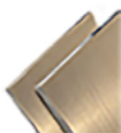

**Ground Plate/
Wear Plates**



**Big Block Plates
ASTM B505 & B22**



**Stock & Custom
Bushings**



Centrifugals



Forgings



Sand Castings



**Made to
Order Parts**

Sales@atlasbronze.com • 800-478-0887 • www.atlasbronze.com

Knowledge AND Connections

You may have noticed that we've spruced things up a bit over at geartechnology.com. The website has undergone a complete overhaul, from the front-end design to the back-end programming and system that allows us to be as efficient as possible in producing and delivering the content you need.

For a long time, one of our mottos has been "Free Knowledge Served Daily," and that theme was at the center of our design process. Our goal was to make geartechnology.com even more focused on the technical content and in-depth reporting that you've come to expect from *Gear Technology*.

In the past, the content on our website was largely the same as what was in the printed magazine. But the same is no longer true. Today, the website is both a storehouse of everything we've ever published in print (in The Michael Goldstein Gear Technology Library), as well as the place where new content is created and delivered, including in online-specific formats like video.

Over at the website, news is updated daily. So when something happens in the gear industry, you'll find it there. When new products are released by the gear industry's leading suppliers, you can read about them on geartechnology.com. Plus, in the printed magazine, we have a limit to how much we can deliver. Only so much fits on a page. We don't have the same restrictions online. Our *Revolutions* blog is updated at least monthly—more often when we're able. And while some of those articles will find their way into the printed magazine, they're most often online exclusives that are sent out via our newsletters and communicated via social media.

The website is also a place of community, so much so that perhaps a new motto is needed. Maybe "Free Connections Made Daily" is more appropriate. One of the best examples of that is our online Buyer's Guide, where the industry's leading suppliers have posted their information so that you can identify new sources to fill the gaps in your supply chain. And while we've had an online Buyer's Guide since we launched geartechnology.com back in 1996, it's gotten better and better over the years, and never so much as with this latest redesign.

The Buyer's Guide includes many new features, allowing the suppliers listed to tell their story in new ways, including the addition of brochures and videos to the company descriptions. In addition, we connect those listings with articles that have been written by and about those companies, so you have a much better understanding of the capabilities, history and background of your potential suppliers. And, of course, the ability to submit an RFQ is built right into the page.



Publisher & Editor-in-Chief
Randy Stott

We're also doing everything we can to integrate *Gear Technology's* information with that of our parent organization, The American Gear Manufacturers Association. For example, AGMA member companies are highlighted and searchable in the Buyer's Guide. Suppliers in the gears, gear drives and gear manufacturing services categories are automatically added to the same categories in our sister publication's website, powertransmission.com, which has undergone a simultaneous overhaul.

Lastly, we've tied together all of our databases, so that you can use the same login for geartechnology.com as you do for powertransmission.com and agma.org. This gives you even greater control than ever over your personal information, including your subscription. I encourage you to log in and renew your subscription today, because it's the only way to ensure that you continue to receive *Gear Technology*, and it's the best way to make sure you're receiving it in the format you prefer (in print, digitally, or both). Most importantly, it allows you to sign up for our e-mail newsletter, which is delivered four times per month and includes links to the latest news and online-exclusive content. And you can also opt in to receive messages from our advertisers and sponsors, including the latest content that *they're* producing, such as technical webinars and white papers demonstrating the state of the art in gear manufacturing technology.

Mostly, though, we just hope you visit geartechnology.com. Check it out, bookmark it, and come back often.



The NIDEC ZE26C Gear Grinder

We also have hobbing, shaving, C/N/C shaping, internal generative grinding, Super Skiving, and external gear grinding. ***We have the expertise to do it all.***

Nidec Machine Tool America



FE30A Shaver



MSS300 Skiver



GE15HS Hobber



ZI20A Internal Grinder



ST40A Shaper



This issue's focus is gear grinding with the **ZE26C**: fast, productive processing of parts up to 260mm OD. Up to 100m/s grinding speed with bias control and polishing options.

We can help you make quiet gears for **EV transmissions**.

*In stock and available **NOW** for immediate delivery. Call now to schedule a test grind of your parts. **We have you covered!***

Visit www.nidec-machinetoolamerica.com and call our sales department at 248-669-6136

LEGENDARY RELIABILITY

Liebherr

OFFERS COMPREHENSIVE SKIVING TECHNOLOGY PACKAGE

Gear skiving is considerably more productive than gear shaping and more flexible than broaching, but it also has its pitfalls. Minimal errors in tool design can be decisive for the success or failure of the manufacturing process. Comprehensive competence is required here, so that the user can be confident that his processes will work and that the highest-quality components will be produced.

The success of gear skiving lies in the significantly higher efficiency and productivity of this process compared with shaping and the considerably higher flexibility and lower investment compared with broaching. However, the requirements for the tools are extremely high. Quality is a must, since minimal details in tool design can be decisive as to whether machining will work successfully.

Practical experience has shown that the mathematical mastery of the process and its coordination with the tool and machine is the key to success. With Liebherr's Skiving³ technology package, the gear specialist is combining its expertise with regard to the tool design, machines and technology of gear skiving.

"We have a holistic view of the process and know exactly which adjustments we have to perform in order to make it work," said Haider Arroum, sales team leader for gear cutting tools at Liebherr.

Liebherr's gear skiving tools are available in conical and cylindrical form and can be optionally manufactured from powder-metallurgical high-speed steel (PM-HSS) or full carbide. For process-optimized tool design, Liebherr uses specially developed software, which simulates the manufacturing process, calculates the required tool profile, and then controls the gear grinding machine to generate the desired profile characteristics on the gear skiving tools. The software detects the profile,

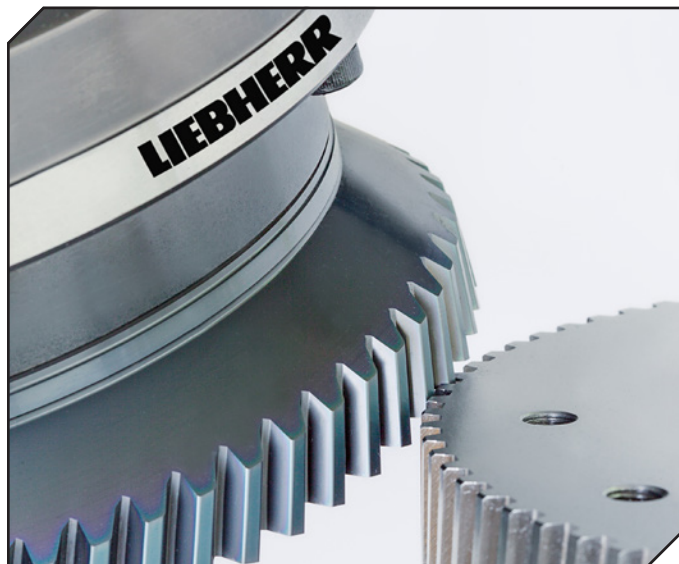

considering the crossed-axis angle and rake face offset, collision avoidance and the optimum rake and clearance angle for the entire process. This enables optimum quality and process reliability to be achieved for all gears.

Whether it is for large-volume production or smaller batch sizes, this means more safety and reliability for the user's manufacturing process.

"Liebherr continually invests in the optimization of quality, tool life and process reliability. Our customers value us as a reliable partner that can also implement individual special features," Arroum added.

liebherr.com/gartechology

Ipsen

EXPANDS SERVICES WITH VACUUM CHAMBER WALL THICKNESS TESTING



Ipsen has expanded its field service capabilities to include ultrasonic wall thickness testing for vacuum furnaces. The test helps customers verify the integrity of their chamber and determine its remaining lifespan.

"Having a better understanding of the furnace's condition will result in more accurate maintenance planning," said Ipsen Chief Service Officer John Dykstra. "Customers can have peace of mind knowing their furnace is safe for operation, while also preparing for future repairs or replacement."

Vacuum chamber wall thickness testing is a service provided by Ipsen's field service

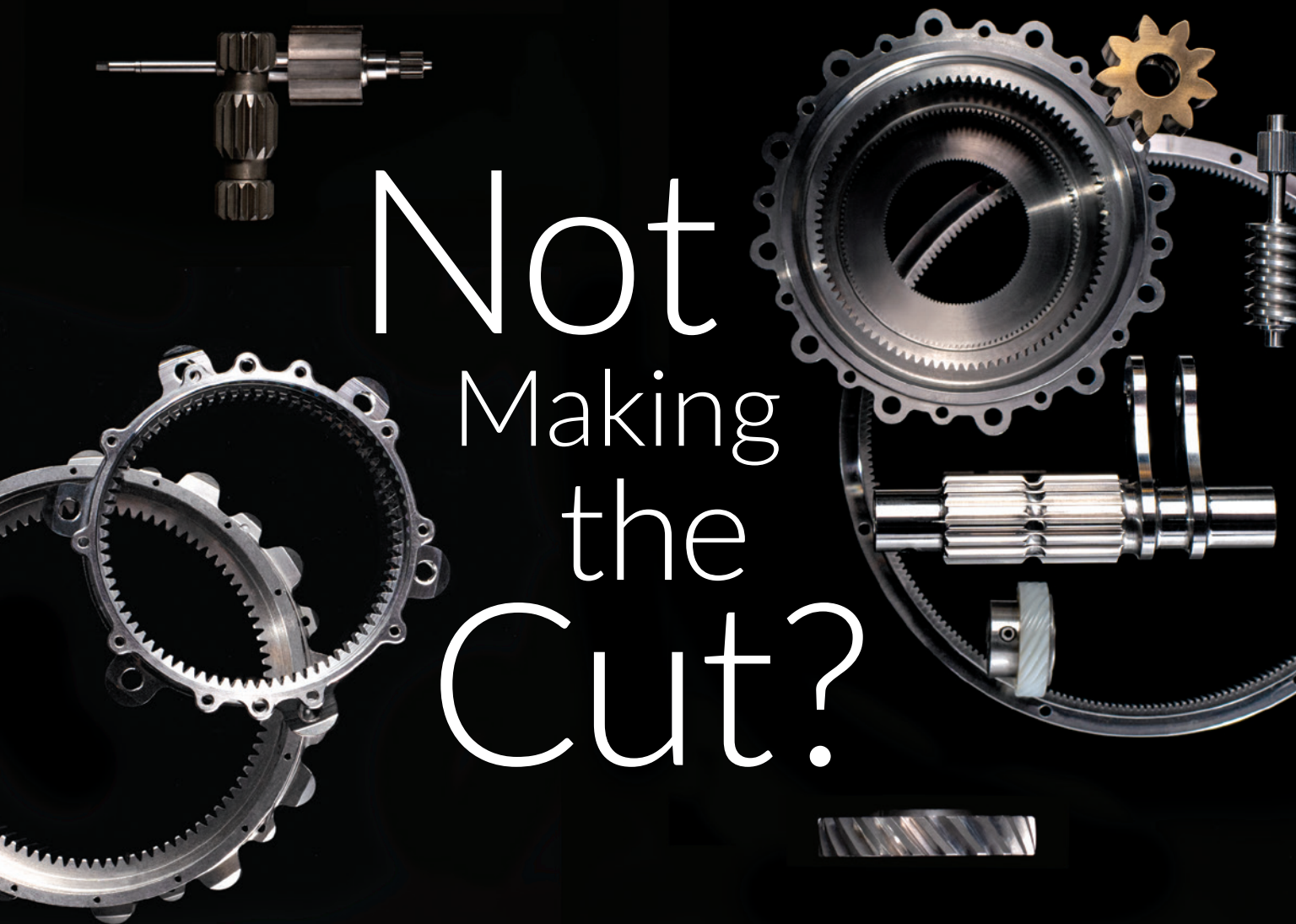

Not Making the Cut?

We're Here to Help.

Quick-turn, High-precision, World-class, Cut Teeth Only Gears



AGMA | WBENC | ISO 9001 | AS9100 | ISO 13485 | ITAR Certified

Spur • Helical • Spline • Worm • Worm Gear • Sprockets
Ratchets • Threads • Ball Screw • Keyways • Face Gears

forestcitygear.com

815.623.2168

engineers using an ultrasonic inspection instrument. This nondestructive method requires only the removal of a small amount of paint at each desired test point.

Ipsen's service team works with the engineering department to determine the appropriate thickness for each chamber wall, and whether it passes or fails to meet the ASME Pressure Vessel Code. When the test concludes, customers receive a detailed report charting the thickness of the chamber wall across a wide range of areas, as well as maintenance and repair recommendations.

The service is now available anywhere in the United States on both Ipsen and non-Ipsen equipment.

ipsenusa.com

Junker

OFFERS 6S AND 6L GRINDING MACHINES

New linear motors and hydrostatic guides in the Junker 6S and 6L grinding machine series open up new potential. Higher speeds, various detailed improvements, and optimized ease of maintenance result in shorter cycle times, maximized quality and cost savings. The expanded modular concept for the table assemblies makes the platform 6 grinding machines more flexible and adaptable.



High-performance linear drives along the x- and z-axes allow high travel and acceleration values whilst simultaneously reducing the assembly space, enabling maximum dynamics and accuracies. The latest measuring technologies help to produce good parts from the very beginning of the grinding process.

Table assemblies, such as workpiece spindles, tailstocks, or steady rests, are installed on standardized universal construction boards, which can be positioned for various workpieces either automatically or manually. The modular concept stands out thanks to a highly flexible component arrangement of table assemblies on guide rails in the working area. The table assemblies can be easily retooled for future grinding tasks. The fact that all guides and motors are fully covered makes the grinding machine suitable for use with either emulsion or grinding oil as a coolant.

The polymer concrete machine stand impresses with its damping performance and high torsional stiffness. The

optimized machine bed rinsing makes maintenance easier, and piping for the media feed integrated into the machine stand allows for future grinding machine upgrades. The decreased machine size also reduces overall transportation costs.

Innovations in the field of cooling, pumps and pressure regulation enable the removal of cooling media harmful to the environment and health. These environmental improvements along with increased energy efficiency reduce maintenance requirements and round off the development of grinding machines with many detailed improvements.

junkergroup.com

Allegheny Performance Plastics

COLLABORATES ON TRANSMISSION GEAR CONVERSION

Allegheny Performance Plastics recently teamed up with GETEC Getriebe Technik GmbH, and Solvay, to explore the possibility of replacing a traditionally metal helical pump gear in a transmission with a Torlon PAI gear. The gear powers an oil pump that is used to circulate oil, to lubricate and cool the transmission. When the car is idling and during low engine speed, with RPMs from 800–2000, this gear is the single largest contributor to system noise.

The use of high temperature, high performance thermoplastic injection-molded parts in automotive applications is growing. The benefits of Torlon PAI include the economies of injection-molding and lower noise, vibration, and harshness (NVH) will continue to drive the replacement of many traditional metal parts with thermoplastic components. Traditionally, thermoplastic parts have been considered for metal replacement on noncritical components. However, during the last decade components manufactured from high performance thermoplastics have replaced bearings and other components in demanding





51ST TURBOMACHINERY & 38TH PUMP SYMPOSIA



SHORT COURSES: SEPTEMBER 12, 2022 SYMPOSIA: SEPTEMBER 13-15, 2022

GEORGE R. BROWN CONVENTION CENTER - HOUSTON, TX

"The TPS is an excellent opportunity to network with a large cross section of industry leaders in the turbomachinery and pump fields. The wide variety of learning and networking opportunities are second to none for this type of equipment. If you did not get a net positive experience out of the TPS, you weren't trying..."

Robert Benton, Rotoflow - An Air Products Business

 **4,750+**
ATTENDEES

 **365+**
EXHIBITING COMPANIES

 **45+**
COUNTRIES



FOR THE INDUSTRY, BY THE INDUSTRY

#TPS2022 

TPS.TAMU.EDU

automotive transmission applications. The Torlon PAI oil pump gear represents a thermoplastic replacement of yet another crucial component and places thermoplastic parts within the critical function of the transmission.

At this early stage, the Torlon PAI gear was designed to be a drop-in replacement. In other words, the plastic part has the exact same dimensions as the metal gear that it is replacing. GETEC completed a full NVH test at their testing facility, and the plastic part performed

3 decibels lower than the metal gear at the critical idling and low engine RPMs. This represents a significant reduction in noise.

Sven Steinwascher, GETEC managing director and CTO said, "The metal gear that we replaced with this first prototype had undergone six years of refinement to reach the level of NVH performance it has today. It's encouraging that we surpassed that on our very first attempt with this thermoplastic part."

Solvay's Head of Marketing-Automotive

Brian Baleno said, "Reducing NVH and identifying components to save space are two significant challenges for electrified vehicle powertrains. Torlon PAI has a long history of replacing metal in thrust washers and bearings so we see metal replacement in oil pump gears as the next evolution and are excited to be partnered with Allegheny Performance Plastics and GETEC to help to refine the part and perhaps even decrease the NVH further."

Greg Shoup, president of Allegheny Performance Plastics, stated, "We know Torlon and we are well equipped to develop machining and injection molding processes that take our customers from application development and prototyping to high-rate production volumes. As we develop this application in conjunction with Solvay and GETEC, we'll be focused on creating a part with a consistent process that can be injection-molded to within very tight tolerances."

Steinwascher added, "The implications of this gear replacement are enormous, nearly every automobile with a DCT or AT that is manufactured has one of these gears, and HEVs often have two. E-vehicles also run much quieter at higher RPMs, which means that lowering the NVH of this particular gear would affect the overall NVH of the vehicle for a wider range of RPMs, not just in idling speeds."

As this process of part development unfolds, the next step for the team is to perform durability testing on the part, as well as refine the part design to further enhance the gear's performance.

alleghenypformanceplastics.com

Feeling Supply Chained?



Hurry up and wait. Seems like the supply chain's affecting everyone's business these days. Our timing's perfect. We've added significant capacity to shorten the distance from you to the custom, high-precision gears you've been waiting for.

Your best gears are closer than you think.

There's a Better Way.



Fine, Medium, Coarse Pitch | Spur, Helical | Shafts, Sprockets, Worms | Straight, Spiral, Hypoid Bevel



SOUTHERN GEAR

800.248.5152 | southerngear.com | 3685 NW 106 St. Miami, FL 33147

Established in 1957 | Veteran-Owned | ISO 9001:2015 | AS9100D | ITAR Compliant

We measure quality in micrometer

WGT 280 - 1200

www.liebherr.com

LIEBHERR

Metrology

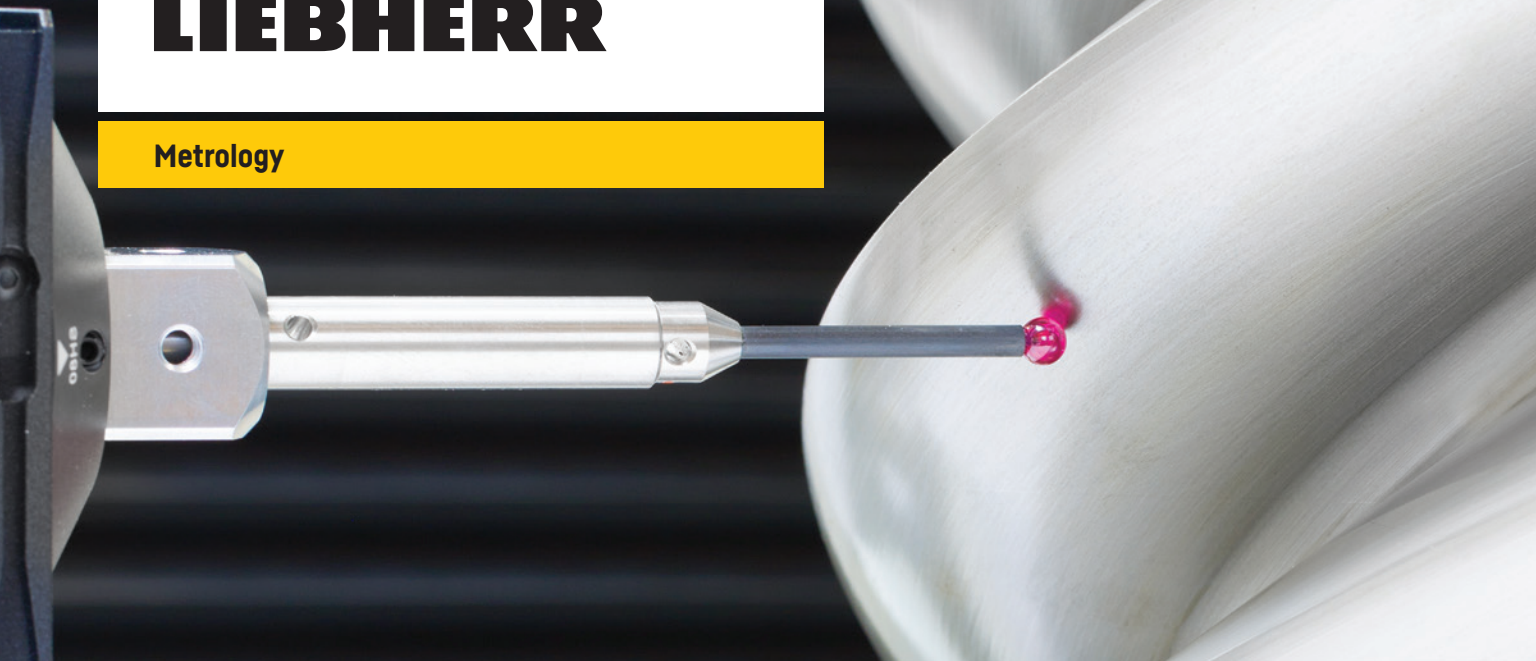

WGT Gear Measuring Machines

Liebherr offers a wide range of gear measuring devices. The combination of high-precision measuring mechanics and the specially developed gear measuring software guarantees precise measuring results.

- Highest accuracy is guaranteed by using granite guides, air bearings, precision rotary table and Renishaw scanning probe
- Low cost of ownership and high uptime
- User-friendly software packages for various types of gears, gear cutting tools and shaft geometry
- Manufacturer neutral GDE interface for data transmission to production machines



Mitutoyo

RELEASES MCOSMOS VERSION 5.0

Mitutoyo America Corporation recently released the newest version of their advanced metrology suite for Coordinate Measuring Machines. This software offers support in thirty-seven separate locations and in twelve different languages.

What distinguishes *MCOSMOS v.5* from its predecessor are the upgrades to its interface, functions, and performance. Most noticeable from launch is the new and simplified graphical user interface: The updates made to this are not only visually pleasing but also assist in improving the user experience, no matter their level of knowledge working with the tool. These changes include easy-to-use “ribbons” and a much-requested search function, assisting operators in finding specific sections of their measuring process for detailed reports.

mitutoyo.com



SMT

Gearbox & Driveline Design, Analysis & Optimisation

MASTA enables engineers to design robust, efficient, light weight and quiet transmissions from concept design, all the way through to manufacture.

Run and generate reports on a wide variety of analyses including NVH, system deflection, durability, FE & more.

Visit smartmt.com/masta to learn more.

MASTA¹¹

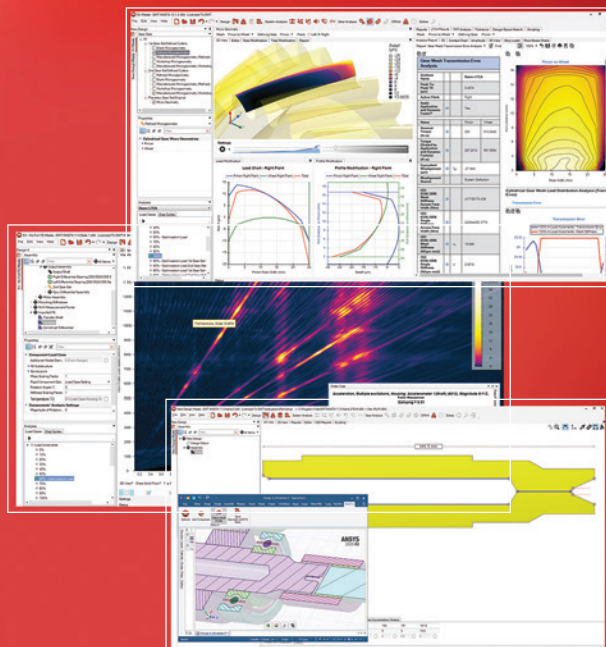

Visit smartmt.com/evaluation-PTE to request a FREE evaluation of MASTA for up to 3 months.

Helios Gear Products

OFFERS LATEST GEAR SHAPING MACHINE

For the first time, gear manufacturers can now access the all-new model M673 CNC gear shaping machine, designed and built by Monnier + Zahner (“MZ”) in Switzerland and distributed in North America by Helios Gear Products.

“This machine tool equips gear manufacturers to profitably produce fine-pitch parts with easy programming, proven automation, and contemporary technical features,” said Adam Gimpert, president of Helios.

Gear shaping is a versatile cutting process for producing external or internal gears and other repeating tooth forms such as splines, sprockets, and serrations. The M673 features 1.25 module (20 DP) Fanuc CNC shaping for parts up to 80 mm (3.15”) diameter, 10–30 mm (0.4–1.18”) stroke length up to 2,000 strokes per minute, a compact footprint, and unified versatile gantry automation. The machine design uses an all-new flexible tailstock concept that allows ample clearance when shaping small parts.

Gear manufacturers of medium- to high-volume fine-pitch jobs will increase productivity with the M673’s set of features, ease of training, and intuitive programming. High-volume, internal gear and spline shaping especially benefit from the M673’s use of automation, high-speed cutting (with carbide cutting tools), and flexible tailstock.

heliosgearproducts.com



afichelin group
AFC HOLCROFT
industrial furnace solutions

Batch Integral Quench Furnaces and Endothermic Gas Generators “Built for Stock”

Leading the Industry with Fastest Delivery Available



We’re always building our industry-leading UBQ (Universal Batch Quench) furnaces and EZ™ Series Endo Gas Generators for off-the-shelf delivery, ready for expedited shipment. The same standard equipment AFC-Holcroft is known for, but pre-built to speed up typical delivery by months. There is no compromise in quality to get this fast delivery.

www.afc-holcroft.com

AFC-Holcroft Headquarters
Wixom, Michigan, USA
Phone: +1 248 624 8191

AFC-Holcroft Europe
Swiebodzin, Poland
Phone: +48 68 41 61 776

AFC-Holcroft Asia
Shanghai, P. R. China
Phone +86 21 5899 9100

EMAG SU

OFFERS HIGHTECH SOLUTIONS FOR CUTTING GEARTEETH

EMAG SU has implemented a whole series of technological innovations for huge improvements in performance, as the example of generating grinding clearly shows: the machines boast short chip-to-chip times, intelligent axis concepts, thermal and mechanical stability, and easy user navigation. With the G 160 for components up to module four with a maximum outside diameter

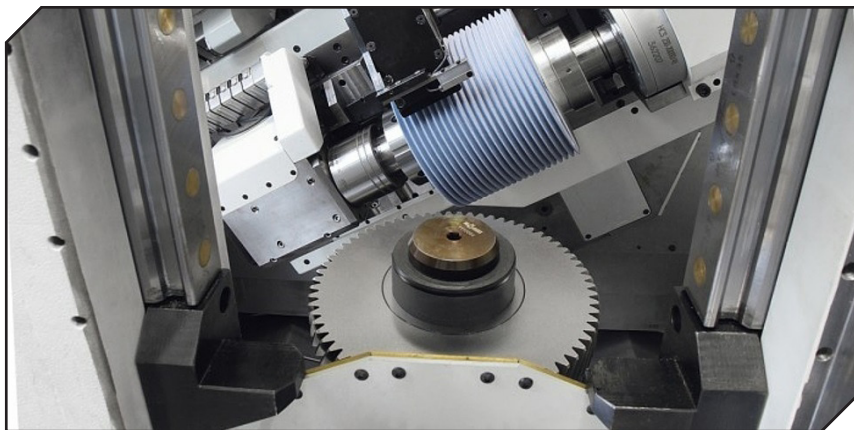

INVOLUTE

Gear & Machine Company



www.involutegearmachine.com

A Perfect Mesh

American ingenuity, service and support teamed with Japanese efficiency, quality and technology.

Kashifuji CNC Gear Hobbing Machines



KN152 Gear Hobber



KE251 Gear Hobber



KPS 201 Gear Skiving Machine

100+ Years of Manufacturing Gear Hobbing Machines

8 Models of Machines from 50 to 1000mm



CNC Gear Inspection and Double Flank Rolling Machines

65+ Years of Manufacturing Gear Inspection Machines

Machine Models to 850mm OD Capacity



CLP-35 Gear Tester



GTR25 Double Flank Gear Roller

46449 Continental Drive
Chesterfield, MI 48047
Phone: 1-586-329-3755
Fax: 1-586-329-3965
rodney.soenen@involutegearmachine.com

of 160 mm, for example, EMAG SU has a fast machine. The speed is made possible by two parallel workpiece tables that take turns moving at high speed (with the help of hard-wearing linear motors) to the grinding wheel.

Just as interesting are the profile grinding machines from EMAG SU for machining external and internal gear teeth, rotors, and worms in small and large volumes. The G 500 H for components up to module 35 mm with an outside diameter of 500 mm and a length of up to 1,850 mm can grind workpieces with internal and external gear teeth with the help of quick-change grinding elements. The long variant GW 7000 H can grind ball screws measuring up to 7 m, for example. This machine can also be equipped with a tool changer, which has great advantages with single-shaft extruder shafts. The GW 3600 HD (4- or 5-axis machine) is designed for economic machining of rotors or worms with a maximum diameter of 500 mm and a length of 2,500 mm. All the machines permit flexible production with short tooling times.

EMAG SU shaving machines can perform all shaving processes, depending on the model and axis configuration – from plunge and parallel shaving to underpass and diagonal shaving. At the same time, tool and workpiece axes ensure productivity with varying batch sizes.

The chamfering and deburring machines from EMAG SU for manufacturing spur and helical gears have short cycle times as well, since chamfering, smoothing, and deburring are combined in one process.

emag.com

SEPT. 12-17, 2022 • MCCORMICK PLACE, CHICAGO

FIND

IT



IMTS 2022

INTERNATIONAL MANUFACTURING TECHNOLOGY SHOW
DIGITAL MANUFACTURING. IMPLEMENTED.

EXPERIENCE
THE POWER
OF **NANO**
INSPECTION

EVALUATE WAVINESS ON A SUB-MICRON LEVEL

Imagine evaluating waviness on a sub-micron level. Gear inspection solutions can enhance productivity with a single, compact platform for the inspection of gears – even fine pitch gears smaller than 0.2 modules! Discover technology like Gleason's GMS nano series at IMTS 2022.

REGISTER NOW AT **IMTS.COM**

LPC Carburizing: The Affordable Alternative to Gas Carburizing

Mark Hemsath, Nitrex Heat Treating Services

Gas carburizing has been around for a long time. One could argue that gas carburizing is the most common heat treating process. Heat treaters performing gas carburizing are often characterized by a dirty environment, hazy surroundings, and that “smell.” While the product quality may be acceptable, gas carburized parts do come with some challenges, like excessive intergranular oxidation (IGO) or intergranular attack (IGA), which is often ground off.

Low-pressure carburizing (LPC) has proven to be a much cleaner and very capable alternative process. Most furnace companies have combined LPC with high pressure gas quenching, which moved carburizing from the dark back room to a relatively “clean room” environment. However, there is still a strong need for oil quenching, which is the common feature of the long used standard integral-quench (IQ) furnace.

As the world establishes strong environmental, social and governance (ESG) policies, electrically heated options with no endothermic gas emissions are really at the forefront of this trend. The heat treat community will need to adjust. In addition to less harmful emissions, an added benefit of LPC is that it offers a comfortable, cool, and clean workplace environment for employees.

The goal is to break the myth that LPC is only for aerospace or special applications, and that it is not affordable. Let’s dig a little deeper into gas atmosphere carburizing versus LPC.

History of LPC

It has been over 50 years since LPC was introduced yet, the technology is still considered “new” or different. “Carburizing” is done with a carbon-rich gas. Over the decades, it has been learned that acetylene gas is unique and readily available. Acetylene, unlike some other hydrocarbons (i.e., propane), does not break down with a combination of low pressures and the high austenitic



Large gears necessitate oil quench (all photos courtesy of Nitrex).

temperature ranges used (Ref. 1,3). Instead, it requires the presence of the metallic surface as a catalyst (Ref. 1). This is very convenient for LPC. In fact, the process has been shown to be so efficient early on, that carburizing speeds, initially, are extremely fast (Ref. 1). What does this mean? It means that LPC can be faster (and hence more economical and more productive) than atmospheric pressure gas carburizing.

It also means that with oil quenching (and LPC), productivity should exceed the older styles of carburizing equipment. By offering oil quenching, Nitrex HTS can build denser loads and still get acceptable quenching results with LPC. The available 20-bar nitrogen high pressure gas quench is also a nice option, for those whose parts can use it or those that desire less distortion.

Being in vacuum, LPC is quite a different process from the old-style atmospheric pressure gas carburizing process, which uses oxygen probes or analyzers to understand when the process reaches equilibrium (Ref. 1,3). There is no oxygen for reference (under vacuum) and

carbon does not transport in and out of the steel in the same manner. Thus, it is not possible to reach an equilibrium situation in the presence of a carbon-rich atmosphere under vacuum. This works out great when doing vacuum hardening because carbon will not leave the steel during austenitizing (known as through hardening or neutral hardening) in the presence of a vacuum atmosphere. However, with LPC, the gases must contact the metal surfaces for elemental carbon to build up on the steel surface. This process means that LPC is, by necessity, a recipe or calculation-driven process (Ref. 1,3). Therefore, it is imperative to understand the reaction kinetics of the material surface, the carbon donor gas behavior, as well as the temperature and pressure profile.

The advances in LPC have been on many fronts over the last 50 years. Of course, controls and software have come a long way, but to be honest, LPC has not become mainstream. It is Nitrex’s belief that LPC has many benefits, and that this method of carburizing will be preferred, through expertise, understanding

the equipment and pricing methods, and through using oil quenching and higher temperature processing.

A Question of Affordability

It has long been known that initial stages of LPC result in faster carbon intake. But how fast? In a new and interesting research using “*in situ* synchrotron X-ray diffraction” analysis, the authors Tapar, Epp, et al. showed:

“The austenitic saturation limit is reached within seconds of the boost steps due to very fast carbon uptake rate from atmosphere into sample. Carbon atoms accumulate at the surface and carbides rapidly precipitate. Therefore, carbon diffusion from the atmosphere to the surface decelerated. After that point, which lasted about 20 seconds, the carburizing reaction changes from an atmosphere-dominated

(process) to a material-dominated (process)” (Ref. 1).

What this means is that the recipe software must understand these mechanisms, especially to avoid wasting carbon gas and promoting sooting. As well, the furnace design engineer must understand that a very large amount of donor gas needs to be introduced very quickly and evenly into the load. Just as important with LPC is knowing the surface area of the parts being carburized.

The authors above further point out that additional boost steps result in slower diffusion as the material-dominated process takes over (diffusion into the steel), and even the accumulation (and catalytic reaction) of the surface changes in later boost and diffuse steps. Therefore, it is also important to incorporate temperature changes into the

recipe process, as it is well known that diffusion is increased substantially at higher metal temperatures (Ref. 1 and 3).

For decades, it has been understood that recipes need to incorporate various “boost” and “diffusion” steps in the cycle. This means we “boost” in a lot of gas to the surface for a short period and then we let the carbon diffuse into the metal. But if you talk to any vacuum carburizing engineer, they all have different recipe creation opinions, and every manufacturer has a different software. Thus, anyone using LPC on a day-to-day basis needs to understand creating effective recipes. This is also the key to affordable LPC processing. Add in the need to really process at higher temperatures, and one can see that expertise is needed to run a well-functioning LPC shop.

With the way that they are designed,

RESIDUAL STRESS MEASUREMENT

State-of-the-art facilities
and superior service.

No compromises.

www.protoxd.com

1-734-946-0974
info@protoxd.com

PROTO
X-RAY DIFFRACTION



almost all vacuum furnaces work even better in higher temperatures. Unlike older gas atmosphere furnaces that employ “high temperature” exotic nickel or cobalt alloys for radiant tubes and fans, and for load support and transport, vacuum furnace designs mostly do not. Thus, higher process temperatures will not degrade the furnace life and will not increase maintenance costs nor add more downtime. Therefore, to process more affordably with LPC, it is desirable to increase the process temperature to speed things up. Much has been written

about higher carburizing temperatures and how it is possible to cut cycle times in half (Ref. 4), so it will not be dwelled on here. Suffice it to say, higher temps really speed things up, shorten cycles and increase productivity.

In atmosphere furnaces, even with exotic, expensive metal alloys used in the hearth components and radiant heating tubes, the alloys will degrade with a relatively modest increase of 150°F, say from 1,700°F to 1,850°F. The figure on page 23 shows RA330 (a common heat treating alloy) and other alloy profiles at

1,700°F and 1,800°F. Creep rates increase and strength decreases substantially (as can be seen, at 1,800°F, most of the alloys are at very low strengths [the scale is logarithmic]).

And with many alloys, if you add in the harsh atmosphere of gas carburizing, problems get even worse. Any furnace designer must balance the need for long furnace life with competitive furnace pricing and maintenance cost challenges.

Therefore, by understanding the science of LPC, it is important to know that these systems are designed to run shorter cycles at higher temperatures, and by going from, for instance, 16 hours to 8 hours, one can double productivity (throughput) in a single chamber. Time is money. Less time means less costs to the customer and more profits for the CHT shop.

Atmosphere Carburizing Rather than LPC

The analysis of gas carburizing compared to LPC can get complicated and it is rather subjective. Some of the hard rules for using conventional gas atmosphere processing, when possible are:

- Carbonitriding
- Small lots
- Mixed loads of parts
- Low processing temperatures desired

For carbonitriding, ammonia is added to make the surface very hard, yet the needs are often for shallow cases. These are shorter cycles. Ammonia under vacuum is very unstable. This means it breaks down (dissociates) very fast. With LPC, in order to do a 30-minute carbonitriding segment, it may require just as much time to reduce the temperature. Also, the carburizing and ammonia segments are usually separated. Thus, carbonitriding is best left to the quick, easy, and inexpensive gas atmosphere method.

Small lots from a customer necessitate just as much initial set-up time as a constantly running program which can last for three or more years. It is much easier to drop these small lot loads into the daily grind of the gas atmosphere carburizing department than to set up and confirm a LPC cycle.

Moreover, many commercial shops may enjoy mixing parts to maximize load size, but with LPC, this gets more

RINGS 4"-144" OD • DISCS UP TO 60"
CARBON • ALLOY • STAINLESS

FORGING AHEAD OF THE PACK



**Fast.
No Fine Print.
No Premium.**

At McInnes Rolled Rings, we provide quality products, shipped in as few as 4 days. And we partner that with exceptional customer service to forge the perfect partnership with our customers.

**MADE IN THE
USA**

**McINNES
ROLLED RINGS**

1.877.695.0280 • www.McInnesRolledRings.com

complicated, as mixed loads need the surface area to be calculated.

Finally, gas atmosphere carburizing works fine at lower temperatures and the equipment will last longer. LPC, especially for deeper case depths, really makes more sense at higher processing temperatures to speed the process along. Sometimes, the CHT shop will get a spec that limits processing temperature to 1,700°F or 1,750°F. It is then probably easier to use gas atmosphere carburizing. As mentioned, gas atmosphere furnace systems prefer lower temperatures since it is not as hard on the equipment. With LPC, one really wants to run at or above 1,800°F (990°C).

When to Use LPC

OK, so why is LPC both “better” and “affordable”?

- Mixing of gases is different in a vacuum than under atmospheric pressure. It is easier to deal with blind holes and difficult contours with LPC.
- Vacuum furnaces are designed to run at higher process temperatures as they do not use conventional alloys of construction.
- Vacuum is, by definition, cleaner.



Modern high production low pressure carburizing furnaces at Nitrex HTS – Aurora, IL.

- Oil quenching allows for more densely designed loads.

Mixing gases in vacuum? Yes, this is very important. Vacuum carburizing is performed in a pressure range of around 10 mbar (1,000 mbar is atmospheric pressure). When a gas is introduced into such a “vacuum”, the gas will behave in

an *ideal manner* and expand to fill the space where there are no gas particles. In effect, this is mixing without the need for fans. This is because, during evacuation, there are less collisions of other gas particles as we evacuate more and more particles. This means blind holes will fill with gases by definition. The process is more complex, but this is a guiding principle. There is an excellent article on this concept (Ref. 7).

Most vacuum furnaces today are designed with water-cooled walls, and they use carbon and graphite insulating and heating element materials. These furnaces are easily designed for constant use at over 2,000°F. Most atmosphere furnaces struggle to not deteriorate at 1,750°F, as they use “high temperature” alloys, and the carbon gases and high temperatures attack and degrade these alloys. Few commercial shops will gas carburize at 1800°F and above, even though it is faster. As mentioned before, there are very few exotic nickel or cobalt alloys that perform well, long term, in a carburizing atmosphere and at temperatures of 1,850°F or above (Figure 1).

The whole process of vacuum heating and cooling is cleaner and devoid of oxygen. In conventional processes, oxygen (and water vapor) is everywhere, hence oxygen probes are used to measure carbon potential. These trace amounts of oxygen results in IGO/IGA and surface finish issues.

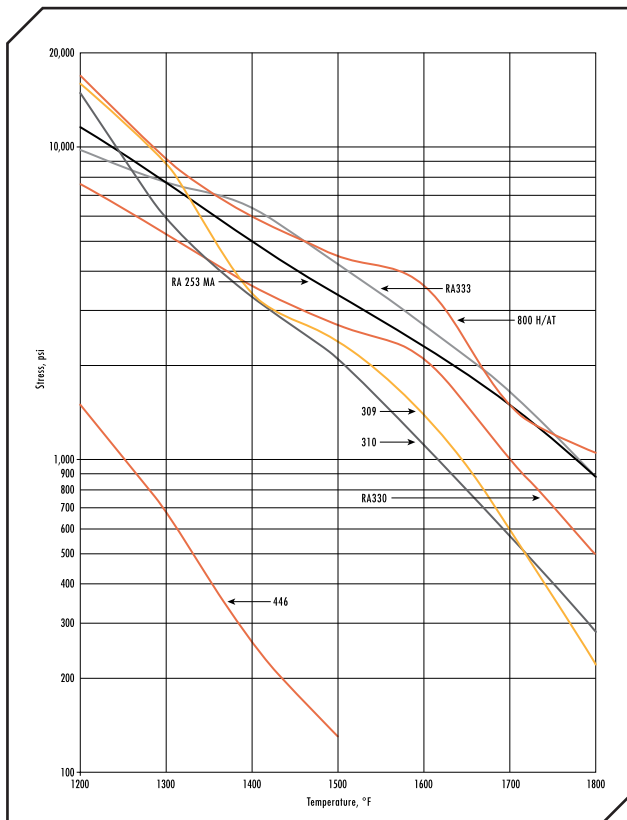

Figure 1 Minimum creep rate for various high temperature alloys, 0.0001 percent per hour, strength graph (Source: Rolled Alloys, Inc. Performance Guide).

It seems most LPC furnaces historically were sold with high pressure nitrogen gas quenching (HPGQ). The problem here is that most steels that manufacturers want to carburize need oil quenching rates. When one complicates this with heavier parts, and load sizes need to be less dense with HPGQ to get uniform gas flows and quenching rates, it is easy to see why it was more expensive and has remained less popular.

There have been some detailed studies performed, and one such study was reported by Herring (Ref. 8).

Methods for Maximizing Value – Tooling Design

Because the equipment for LPC is expensive and furnace chamber sizes (and hence load sizes) are often not



In order to maximize weights and use higher temperatures, rethinking load tooling is a requisite.

as large due to gas quenching limitations, users need to know some tricks to increase load sizes and, in turn, productivity.

Fixtures for any furnace can get expensive and this fixture tooling is often bulky, heavy, and made from the same alloys that we have been discussing. As well, high temperature alloys that can survive a carburizing atmosphere and constant oil quenching stresses are not cheap! Constant oil quenching and high temperature carburizing are very destructive to alloys. Throw in the

higher process temperatures desired with LPC, and we have problems. But the worst one is that we are using heavy alloys and reducing the ability to add parts to the load that can be processed and make money, due to the load weight limitations of any furnace.

As mentioned before, LPC has three loading limitations—surface area, separating parts properly, and weight. Alloys are heavy and, at high temperatures, tooling fixtures need to be built bulky and heavy. This reduces as much as one third of available load capacity.

CFC fixtures can be as much as 10 percent of the weight of alloy fixtures. So, in a 1,500lb. maximum load, if alloy fixtures were 500lb., then we could save over 400lb. and use that extra load for money making parts instead (Ref. 5).

CFC, unlike alloys, retains its strength at higher temperatures, so it can be built without designing for temperature-related substantial reductions in strength, as with alloys. At these high use temperatures, alloys exponentially lose their strength. As well, CFC fixtures can easily handle process temperatures up to 2,000°F. The only limitation with CFC relates to contact points with metal parts at elevated temperatures (Ref. 5).

CFC is not as “robust” as alloys in the day-to-day rigors of running a heat treat operation. For this reason, combinations

of CFC-alloy designs for fixtures also have been used. In Figure 4, we show a more robust cast tray made of a high temperature alloy, with the CFC fixture mounted on top. This uses the strengths of both designs and accepts some heavier weights as a trade-off to increase robustness, limit breakage and ease transferring loads at high temperatures. The article (Ref. 5) discusses CFC fixtures, oil quenching and tempering.

Future Considerations

Carburizing in a vacuum low pressure environment is not new. However, even today, the amount of carburizing performed by atmospheric gas carburizing far outweighs the use of LPC. Using LPC requires a commitment to the process and its benefits. Investing in LPC requires a faith that the furnaces can provide a return on investment, which is often much higher than for standard equipment. ⚙️

nitrex.com

References:

1. Tapar, O., Epp, J., et al., “In -Situ Synchrotron X-ray Diffraction Investigation of Microstructural Evolutions During Low-Pressure Carburizing.” *Metallurgical and Materials Transactions A*, Volume 52A, April 2021, pgs. 1427-1442.
2. Korecka, E., Korecki, M., et al., “Calculation of the Mixture Flow in a Low-Pressure Carburizing Process,” *Metals* 2019, 9-2019, p. 439.
3. Herring, D., “A Case for Acetylene based Low Pressure Carburizing of Gears,” *Thermal Processing*, 9-2012, pgs. 40-45.
4. Hemsath, M., Herring, D., “The Future of the Integral Quench Furnace,” *ASM Heat Treat Conference Proceedings*, 2019.
5. Hemsath, M. “CFC Fixtures Increase Productivity in Carburizing, Nitriding, and FNC,” *Gear Technology*, March/April 2021.
6. Cronite Group, “CFC/Alloy Hybrid — The Next Generation Solution.” *The Monty website (www.themonty.com)*, August 2020.
7. Herring, D., “A Layman’s Guide to Understanding the Theory of Gases,” *HeatTreatToday.com*, Best of the Web, 2014 (original 2014).
8. Herring, D., “Technology Evolution of the Integral-Quench Furnace,” *Industrial Heating*, January 2020.

For Related Articles Search

LPC Carburizing

at www.geartechnology.com

FEELING SOCIAL?

Interact with your Gear Industry peers at www.geartechnology.com.

- Gear Technology blog
 - Ask the Expert
- Follow us on Twitter
- Join the Gear Technology group on LinkedIn (3,300 members and growing!)



Follow us on Twitter
twitter.com/#!/Gear_Technology



Connect with us on LinkedIn
www.linkedin.com/groups/Gear-Technology-Magazine-3893880



Subscribe Online
www.geartechnology.com/subscribe.htm

Hardness Testing Gears – Know Your Options for Best Results

James M. Clinton, Special Order and Technical Support Manager – The L.S. Starrett Company

Gears must be manufactured to withstand extreme forces and challenging conditions, so hardness testing to determine material integrity is key. Understanding the different hardness testing types and systems can be useful to determine an optimal solution. Hardness testing functionality has evolved and now users can dial into world-class caliber instrumentation which more closely aligns with their applications at hand.

Hardness Testing Defined

One of the most common indentation hardness tests used today is the Rockwell hardness test, and although less widespread, the Brinell and Vickers hardness tests are also utilized. The majority of indentation hardness tests measure the deformation that occurs when the material being tested is penetrated with an indenter. Two levels of force are applied to the indenter at specified rates and dwell times when performing a Rockwell hardness test. This is different than the Brinell and Vickers tests, where the size of the indentation is measured after the indentation process. The Rockwell hardness of the material is based on the difference in the depth of the indenter at two specific times during the testing cycle. The value of hardness is calculated using a formula that was derived to yield a number falling within an arbitrarily defined range of numbers known as a Rockwell hardness scale. Regardless of the Rockwell scale or indenter being used, the overall Rockwell test procedure is the same. The majority of today's newer machines automatically perform the entire test. Also, when leaving a mark or indentation is not an option, nondestructive ultrasonic technology can be used.

Rockwell Hardness

When testing the hardness of carbon steel, alloy steel, cast iron, nonferrous metals and engineering plastics, digital Rockwell benchtop hardness testers

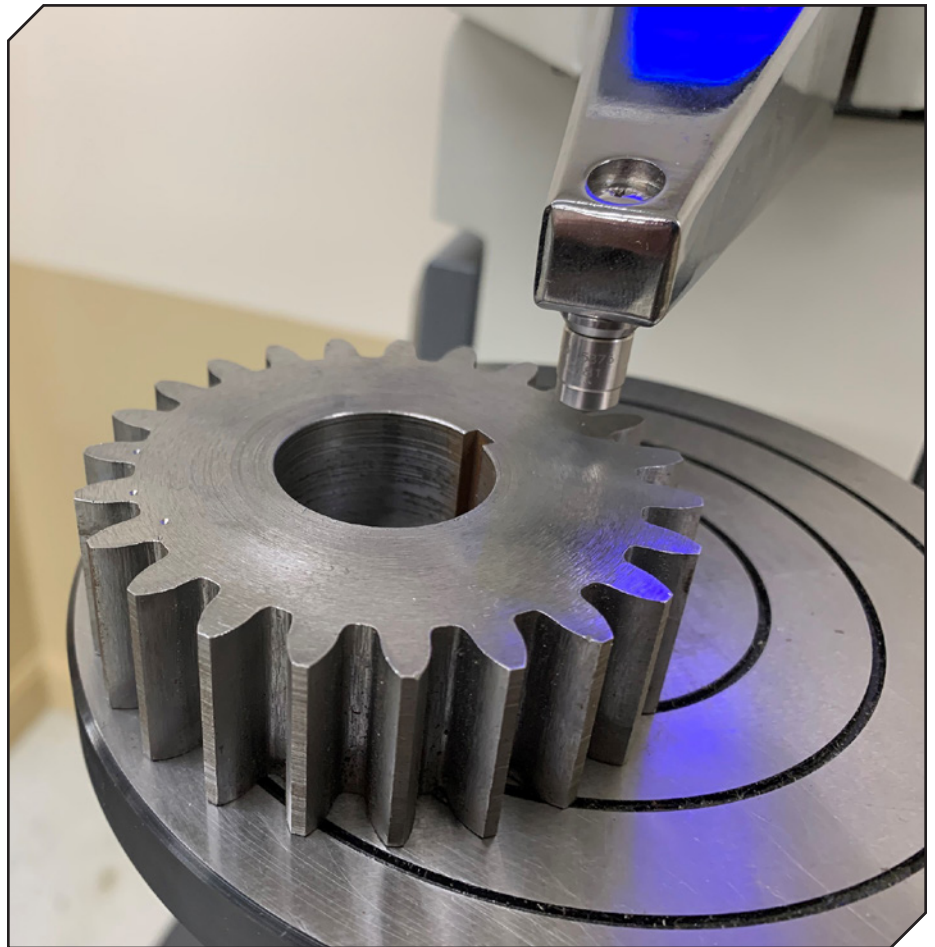

Starrett digital Rockwell/ Superficial Rockwell Benchtop Hardness Testers with a dolphin nose can test the ID of gears, and also gear teeth.

can be used to directly measure in the most popular regular Rockwell hardness scales and can quickly convert that hardness value into HB, HV, HK and many other scales. Desirable hardness tester features include the ability to obtain ultra-precise results, a wide measuring range, and scale/selectable test force capabilities. Also, automatic main test force loading/unloading, a high-resolution digital display and USB data storage are all very advantageous.

A user-friendly touchscreen interface can speed operations and the ability to use USB output to a flash drive is excellent for data mobility. There are options to apply the weight load such as on digital systems that use weights to apply the load or use a closed loop load cell to apply

the weight load. The latter affords greater precision and repeatability. With a weight loaded system, the level of the machine is of great importance, so that the weights drop correctly. This is a less critical matter when using a load cell system.

Conforming to ASTM E-18 Superficial Rockwell hardness standards, hardness testers in this category offer excellent repeatability in all Superficial Rockwell hardness scales. Superficial Rockwell hardness testing is designed for very thin and soft workpieces. The systems are ideally suited for a wide range of environments including inspection labs, heat treat facilities, tool rooms, workshops and laboratories. For more versatility, twin hardness testers are capable of testing in all of the regular Rockwell and Superficial

Rockwell hardness scales.

Dolphin nose systems allow for the hardness testing of inner, as well as exterior, diameters. This allows for easier access to test gears, gear teeth and other hard to access areas. The systems are generally larger in size than other Bench Rockwell systems, offering greater testing heights and depths. Dolphin nose models offer a manual handle that activates the preload system, or an advanced Auto z-axis preload system. Using the Auto z-axis preload system, after placing the workpiece in testing position, the operator only needs to press the start button for the machine to complete the testing process.

Brinell Hardness

Brinell hardness testing is commonly used for very large, porous testing of less hard metals, such as castings. Benchtop systems available today can handle the most popular Brinell hardness applications, and incorporate the latest innovative closedloop technology. A test load is applied via a closed-loop control unit with a load cell to apply weight loads up to 3,000 kg, a DC motor and an electronic measurement and control unit. The result is highly accurate Brinell hardness measurements at all test loads up to 0.5 percent. A common load overshoot or undershoot, also known as traditional dead weight or open-loop, system is eliminated. The absence of mechanical weights not only eliminates friction problems but also makes the equipment less sensitive to misalignments caused by vibrations. The systems are ideal for laboratories, workshops, tool rooms and inspection labs.

Software driven digital optical systems offer advantages over manual microscopes that are supplied with several hardness testing machines. Connected to a PC, laptop or tablet, the operator can push a single button to take automatic and instant measurements. All graphics can be saved, along with test results, in either word or excel formats.

Vickers/Knoop Hardness

Vickers/Knoop hardness testing is done on extremely thin/small workpieces, and often used for checking the hardness of layers, or platings and coatings on small parts in a laboratory environment. A

high level of preparation is needed for such testing, including but not limited to, a high degree of polishing.

There are three types of turret control including a basic manual turret for changing from optics to indentation and



Gearing your past to power your future.

Breakdown Services
We understand the urgency of meeting critical deadlines. We offer our customers expedited services without sacrificing quality.

Heat Treatment
Our in-house heat treat facility performs a full range of services that include annealing, carburizing, and thru hardening.

B&R
MACHINE AND GEAR CORP.

B&R Machine and Gear Corporation is a full service gear manufacturing facility driven to power your equipment with reliable and durable gears that are built to perform and last. Find the perfect mesh. No matter the gear, we've got you covered.

VISIT OUR WEBSITE BRGEAR.COM FOR MORE INFORMATION

back to optics for measuring. A second type incorporates an automatic turret, giving operators greater freedom to change the turret position by a button on the tester keypad. The most popular Vickers/Knoop hardness testers have a turret control option using software to control the entire test with a one-click process using calibrated auto edge detection. Precision video and measurement software also allows for clicking of the indent edges in software, then deriving a hardness reading on screen.

Designed for the accurate hardness testing of small precision parts, thin materials, case-hardened layers and all sorts of steel components, Micro Vickers hardness testers utilize weight loads of under 1 kg, while Macro Vickers hardness testers utilize larger weight loads of up to 50 kg. This type of test bridges the gap between the superficial Rockwell and Micro Vickers machines. These systems have a manual turret.

Vickers hardness testers are generally operated in a lab type environment and will do tests nondestructively. A high level of surface finish preparation is required, and the test process is slow, though it can be automated. This scenario is ideal for gear inspection/testing in a post-production line process.



Starrett digital Rockwell/Superficial Rockwell Benchtop Hardness Testers feature fully automated load/unload procedures, and are capable of providing highly accurate readings.

“Ultrasonic portable hardness testers probably offer the best of most worlds for gear inspection/ testing. Testing can be done from any angle, while getting into very tight spaces often found in gears. Because testing can be done nondestructively, whether you are checking material or platings, tests can be accomplished without leaving a mark on most metals.”

Shore Testers (Durometers)

Shore Portable hardness testers are targeted for testing materials such as rubber, soft plastics and leather, and versions are also available for the testing of hard plastics such as bowling balls and hard hats. Electronic durometers for measuring Shore A and Shore D values are designed to fit comfortably and firmly in a user's hand. A large LED display and simple 3 button control make this device easy to use.

Portable Hardness Testers

There are two popular digital methods of portable hardness testing. The first is “dynamic impact,” based on the Leeb principle of hardness, developed by DietMar Leeb in the 1970s. A spring loaded impact body is thrust to the test surface, affecting rebound. Initial thrust and rebound speed is measured in a noncontact mode, and is calculated as a Leeb hardness value and then automatically converted to Rockwell C, B, Brinell, Vickers and Shore Values. Also, the portable benefit means the tester can be brought to the workpiece, which is especially useful when testing large and/ or cumbersome parts. This method has resulted in efficient, fast and accurate portable hardness testing results.

However, when a mark or indentation on the workpiece must be avoided, ultrasonic testing is a great solution. Advanced non-destructive portable hardness testers utilize ultrasonics with Ultrasonic Contact Impedance (UCI) technology, enabling a portable hardness tester to test special surfaces on small and thin workpieces without marking the surface. These units can test metals as thin as 2 mm throughout all scales, hard or soft. UCI technology is available on both manual and motorized systems. The motorized probe systems are used for very thin testing of coatings and platings, or surfaces with a very high polish finish.

Ultrasonic portable hardness testers probably offer the best of most worlds for gear inspection/ testing. Testing can be done from any angle, while getting into very tight spaces often found in gears. Because testing can be done nondestructively, whether you are checking material or platings, tests can be accomplished without leaving a mark on most metals. The speed of the UCI tests is approximately 2 seconds. In addition, workload can be automated using fixturing and a stand to hold the probe in place, allowing for rapid, continuous testing.

UCI is based on a 136-degree diamond at the end of a vibrating rod being depressed into the test surface at a fixed load. The difference in Ultrasonic vibration frequency is then calculated into a hardness value. The UCI test procedure is slower than the Dynamic Impact style, however the UCI method has the

advantages of being nondestructive and able to test thin and small work parts.

Previously, destructive indentations made on such sample pieces meant the garbage heap for those tested. Using ultrasonics, this is no longer the outcome. These systems have an open architecture and can be calibrated to read any metal, in any hardness scale, with reference samples to perform initial calibration. Ultrasonic portable hardness testing is ideal for applications such as gears, bearings, pistons and valves, among many others. Key industries for this type of testing include aerospace, automotive and medical parts as well as knife blade manufacturing, to name just a few. 

starrett.com



Starrett 3821 Ultrasonic Portable Hardness Tester will test gear teeth nondestructively and can read in just about any scale at about two seconds.

For Related Articles Search

hardness testing 

at www.geartechnology.com

All The Gear Cutting Tools You Will Ever Need Are Right Here DTR is one of the world's largest producers.

DTR. Your best choice for high quality gear cutting tools.

DTR is a world class supplier of the finest high performance long-life gear manufacturing tools, for small and large gear cutting applications. Established in 1976, we are one of the world's largest producers of cutting tools, shipping to over 20 countries.

DTR offers a full line of gear cutting tools including:

- Hobs
- Carbide Hobs
- Shaper Cutters
- Milling Cutters
- Chamfering and Deburring Tools
- Broaches
- Master Gears

We can produce virtually any tool you need for auto, aerospace, wind, mining, construction and other industrial gears.

Every tool is precision-made utilizing high speed steel, premium powder metal or carbide and the latest in coatings, to achieve superior cutting and long life. DTR uses top of the line equipment including Reischauer CNC grinders and Klingelnberg CNC sharpeners and inspection equipment.

Learn more about our outstanding quality tools at www.dtrtool.com.

Call us at **847-375-8892** for your local sales representative or
Email alex@dtrtool.com for a quotation.



DTR

PERFECTION MOVES US

(formerly Dragon Precision Tools)

WWW.DTRTOOL.COM

DTR has sales territories available. Call for more information.

U.S. Office Location (Chicago) Email inquiries to: alex@dtrtool.com.

1261 Wiley Road, Unit K, Schaumburg, IL 60173

PHONE: 847-375-8892 Fax: 224-220-1311

Headquarters

85, Namdong-daero 370beon-gil, Namdong-gu, Incheon, Korea, 21635

PHONE: +82.32.814.1540

FAX: +82.32.814.5381

Kapp Niles Examines Intelligent Rolling Grinding for E-mobility

Martin Witzsch, Freelance Journalist on behalf of Kapp Niles

Fully electric vehicle drives usually require two-stage, non-switchable transmissions. One would think that this greatly simplifies the production. Finally, the described transmission structure has just four gears, distributed on the drive shaft, the second stage with fixed wheel and intermediate shaft as well as the axle drive wheel. But the conditions are not that simple: First of all, the engine speeds of the electric drive with up to 16,000 rpm are much higher than those of the combustion engine.

For this purpose, electric motors deliver an almost constant torque over a wide speed range. Unlike the combustion engine, it is already attached to the transmission from zero speed. In addition, there is an additional boundary condition that makes production much more demanding than with the conventional powertrain.

“A combustion engine masks the transmission noise so that it is not even perceived. An electric motor, on the other hand, is almost silent. At speeds of around 80 km/h or more, rolling and wind noise are the dominant factor, regardless of the powertrain. But in the area below, the transmission noise can be disturbing in electric vehicles. We also have to take this into account when manufacturing the gears,” said Friedrich Wölfel, head of machine sales at Kapp Niles.

Of course, the flank load capacity of the gears and good running properties are also in the foreground with electric drives. However, the almost constant torque level and the high speeds require a different design of the gearing, which in turn can affect the noise behavior. Here, the demands are higher than with the combustion engine.

On the other hand, there is no difference between gears for electric vehicles

and conventional drives when it comes to the pressure to produce them with maximum efficiency. Accordingly, the highly productive rolling grinding process is also generally used as a fine machining process in the series production of e-mobility gears.

For Kapp Niles the task is to realize an equally productive and, above all, optimized rolling grinding process with regards to the noise behavior.

Tracking down transmission noise

Here are the basics:

“Depending on the structurally defined modifications of the gears such as line corrections, width balls, head retractions, as well as the so-called process-typical profile and line entanglements, characteristic noises are generated in the gearbox during the procedure, which can be assigned to certain tooth intervention

Grinding of an eMobility gear.
All photos courtesy of Kapp Niles.

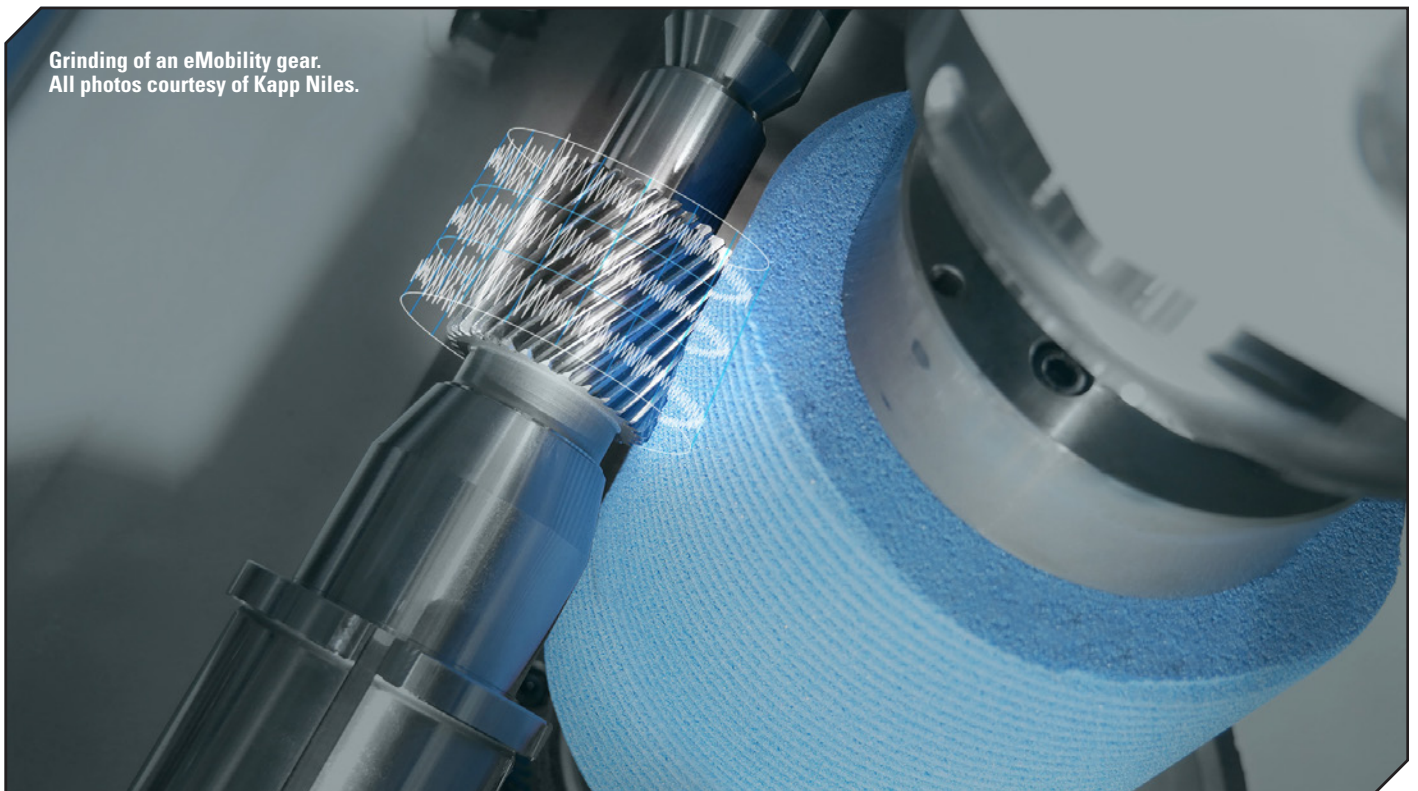

frequencies,” said Achim Stegner, head of pre-development at Kapp Niles. “The entire gearbox, on the other hand, also has characteristic properties with regard to structure-borne noise and radiation, depending on the design. The excitation takes place in the tooth intervention frequency and its multiples. Manufacturers are trying to keep this effect as low as possible by adapting the design of gearboxes and gears.”

Initially, these considerations only apply to ‘perfect’ gears. But of course, like any other mechanical component, gears also deviate from the ideal target geometry in series production. These have different causes and effects, as Stegner explained: “In addition to the stimulation caused by the tooth intervention, there are other disturbances that can lead to noise in the tooth intervention. These make themselves felt as so-called ghost frequencies. These are frequencies that do not coincide with the tooth intervention frequencies and their multiples, and which can also be introduced into the component during grinding.”

The causes of ghost frequencies are minimal irregularities that can hardly be completely avoided in series production. It becomes particularly critical when these deviations are mapped almost integers on the circumference of a gear wheel, as this leads to a harmonious excitation. It requires a lot of know-how and process experience to identify the reasons for such irregularities and to avoid them as far as possible in advance.

The cause of such disturbances can be found, for example, in the axle drives of the machine tool used. Electric motors have certain pendulum torques. Measuring systems work with discrete line numbers and finite eccentricity errors from assembly. Finally, the balancing state and spindle bearings can contribute to possible irregularities. Even ripples in the size of $0.1\ \mu\text{m}$ or more can lead to noise when geared.

“Every machine has natural vibrations. For example, the typical natural frequency of a workpiece spindle is about 250 Hz. In the event of an unfavorable speed constellation in the rolling grinding process, this can also be reflected in integers on the workpiece. We can eliminate such effects with our knowledge of the clever selection of a suitable speed window during machining,” said Stegner.

Once the optimization potential on the machine side has been exhausted, there are also a number of technological possibilities to improve the component quality with regard to noise behavior. These include the choice of the gear number of the grinding screw, the speed ratio during dressing and grinding, the finishing speed and the feed speed.

Not all errors are the same

Roughly speaking, there are two typical types of defect patterns in gear grinding in the series: On the one hand, trends are emerging that show a continuous change in characteristics. On the other hand, there are individually conspicuous components. Trends are usually easier to master. They are caused, for example, by the gradual wear of a grinding screw. If permissible manufacturing tolerances are exceeded here, it is usually sufficient to shorten the cycle between two dressing processes. They can also be easily detected during component testing by gradually bringing the measured values closer to the tolerance limit.

Component-specific errors, on the other hand, are not foreseeable. They are noticeable by sudden deviations in one or more quality criteria. This can be caused by grinding screw breakouts, blank defects or set-up errors.

Since in highly efficient manufacturing processes such as rolling grinding, the actual machining of a gear wheel takes much less time than the control measurement, 100% of all components cannot be tested. In addition, as

described at the beginning, the quality requirements for gears for electric transmissions are extremely high.

“The required tolerances of profile angle, flank line angle, concentricity, two-ball dimension are sometimes smaller by a factor of 3 than in the conventional drivetrain. With the flank line angle error f_{HIS} , a typical requirement is $\pm 4\ \mu\text{m}$, with combustion engine transmissions this was sometimes $\pm 13\ \mu\text{m}$,” Wölfel described the requirements of his customers. Together with the required machine and process capabilities, these quality requirements are on the edge of what is technically and economically feasible. And even static and dynamic stability of the processing machine and process cannot be increased arbitrarily. The only way out is to start with the analysis and control methods. Otherwise, the following applies: The tighter the tolerance limits become with the same machine/process capability, the greater the number of measured components must be. However, this is associated with great effort. And finally, a downstream component inspection is not adding value.

The closed loop has already established itself as an important tool today. This accelerates and improves the feedback between downstream gear measurement and the processing machine itself. Here, the results of the test are no longer printed out on the measuring machine and made available to the machine operator for evaluation on paper, but are transmitted directly to the processing machine as a standardized file. The grinding machine then independently decides on the basis of pre-selectable tolerance corridors whether the process needs to be intervened at all, for example with scalable correction values. If unexpectedly high deviations from the target geometry occur, the decision to proceed is then again up to the operator himself (Figure 1).

The arbitrator at the end of the manufacturing process

At the end of the manufacturing process of a complete gearbox, there is a so-called end-of-line test bench. There, not only individual gears are tested for their quality, but fully assembled gearboxes are evaluated. They undergo various test cycles that simulate subsequent operation in the vehicle. The operating noise is also recorded. Through a corresponding evaluation of this data, acousticians can read out intervention conditions, typical frequencies and possible disturbing noises.

“Unfortunately, gearing errors are only noticed at the end of the manufacturing process,” Wölfel added. “Then the complete gearbox has to be dismantled, the individual components checked and, based on this, analyzed to determine which component is responsible for the conspicuousness on the test bench. A complete batch of components may also cause problems. However, this is only noticeable when the entire value chain has already been completed.”

Today, there are certainly ways to identify components that could cause noise before they are installed in the transmission. A very common method in electric drives is the so-called waviness analysis on gear surfaces. Profile, line and pitch measurements are carried out on all teeth on the gear measuring machine and strung together in such a

way that the gear wheel is mapped over its entire circumference. By means of mathematical methods, the ripple on the gear wheel can be detected. However, starting with the complete measurement of the gears, this method is very time-consuming and therefore unsuitable for 100 percent testing in series production.

“The grinding time of typical e-transmission components is less than one minute, while the measuring time is four to six minutes; with an all-tooth measurement as the basis of a ripple analysis even significantly more. And finally, a downstream component inspection is not value-adding. What is needed here is a further development of the in-process analysis, which already allows conclusions to be drawn about the generated component quality during machining,” Wölfel said.

Detect possible noise problems already during processing

A promising approach is actually to identify possible errors during grinding. Process monitoring is the ‘buzzword.’ Stegner explained this approach: “We already have numerous sensors and measuring systems in the machine that can provide us with a lot of signals, measured values and information. At the moment, we only use them primarily to operate the functions of the machine. In the future, however, we also want to use them to assess the machining process directly in the machine.”

However, this does not mean integrating an additional tactile measuring function into the grinding machine in order to achieve a faster closed loop. Nor is it a question of testing and evaluating a ground component directly in the machine and correcting any deviations in the production of further components. The focus is rather on the analysis of the machining process in real time to detect deviations from a previously defined reference process. However, it is not enough to define only envelope curves for signals from the machine. This can be explained by way of example using the signal ‘Current consumption of the grinding spindle’ in Figure 2. This signal can be used to detect a possible flank line angle error (f_{HB}) at an early stage. “However, the method of envelope detection reaches its limits here, as the error is difficult to identify. As long as the signal remains within the envelope, no alarm is triggered. So, you need a more intelligent form of evaluation. An artificial intelligence that tries to recreate human decision-making structures. He makes decisions from a variety of different information — superimposed with his experience — according to which he acts,” Stegner said.

Process monitoring: Intervene before it is too late

Process monitoring can be defined as component-specific monitoring and evaluation of the grinding process. As described, it is not trivial to generate instructions for action from the sensor signals. But it is possible. Various characteristic values can be formed from time signals. In the simplest case, these can be maximum or root mean square (RMS) values of the signals. The characteristic values are then combined with the known project data via algorithms and processed into indices, for example, into a noise or screw breakout index.

“For noise-critical components, an order analysis similar to the order spectrum on an end-of-line test bench can be created via fast Fourier transformation (FFT). This allows the recorded

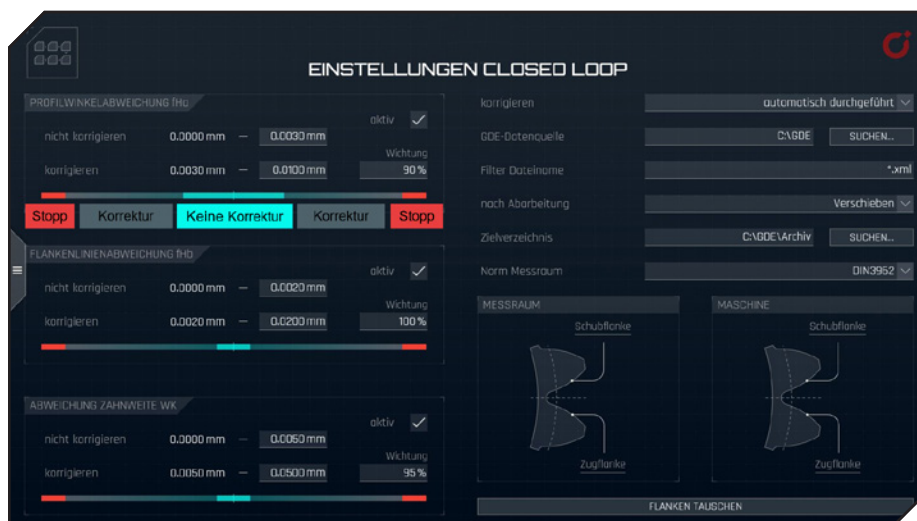

Figure 1 Tolerance corridors for the closed loop.

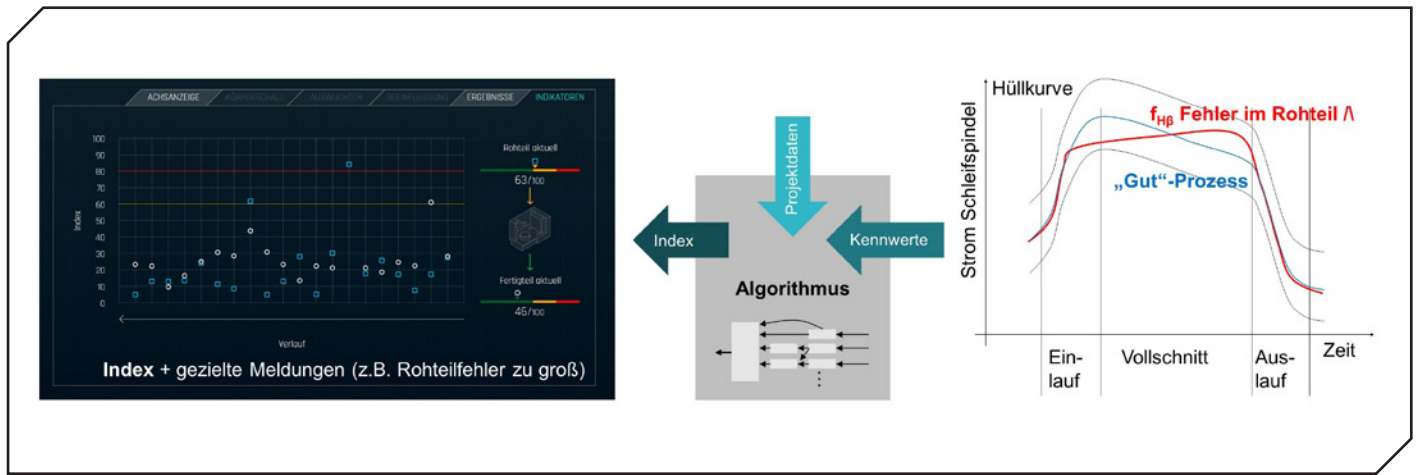

Figure 2 Error analysis and index calculation in the machining process.

signals to be better classified and related to results on the transmission test bench (Figure 3). Nonprepared measurement data have no use,” Stegner explained specifically about transmission noise.

In the end, especially in the manufacturing environment, only appropriate indices help to identify very specific errors.

Benefits of process monitoring therefore can be determined by 100 percent testing of all components, the identification of abnormalities still in the grinding process, detection of component-specific errors, targeted reporting of irregularities, adaptive intervention in the process and parts tracking.

Next step: Standardization

Process monitoring is not yet an app that can be easily downloaded and used. Rather, it is a customer- and application-specific development that defines and monitors indices related to the respective

component. But even this first step is much more than was thought feasible until recently.

“Several pilot customers are already using this functionality today. We can currently already detect various errors and also intervene on the process side. In addition, we are already working on ensuring that the grinding machine learns characteristic values for new components itself. Of course, this requires broad experience from fault patterns, the geometric quality of the components and corresponding feedback from the transmission test bench,” Stegner said.

“The next goal is that the user can use this functionality even without our component-specific support. It is also important to understand that process monitoring, and the closed loop do not contradict each other, but complement each other,” Wölfel said.

Both approaches to process-integrated quality assurance are already available

for Kapp Niles machines today and are continuously receiving further functional scopes and possibilities of use through the experience gained from series production. 

kapp-niles.com

(Additional edits by Matthew Jaster, Senior Editor, *PTE* and *Gear Technology*)

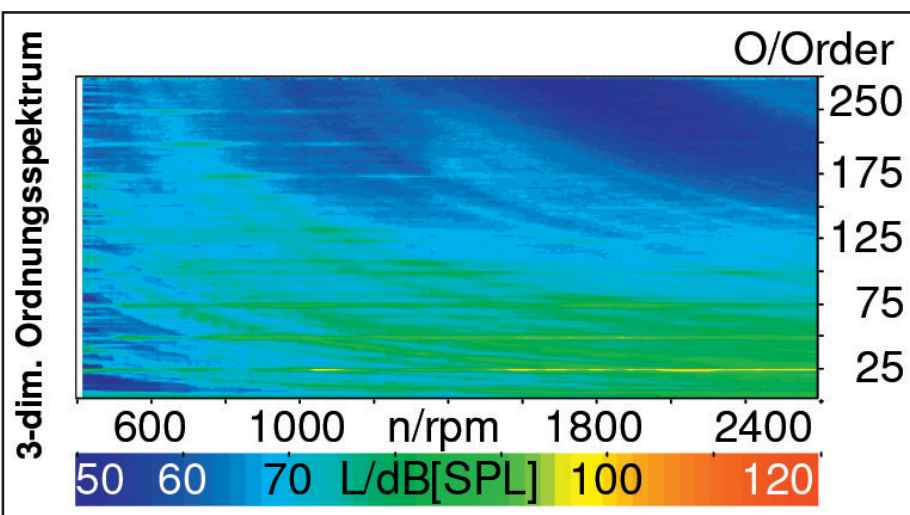

Figure 3 Order spectrum taken on a gearbox test bench.

For Related Articles Search

grinding 

at www.geartechnology.com

The New Age of Bronze

Supply chain constraints and fast-rising commodity prices are taking their toll. Here's how one Midwest producer of bronze gear blanks is helping gear manufacturers "re-shore" – and shorten the distance from bronze blank to finished gear.

Eric Blickley, vice president, R&D and technology deployment, Fisher Barton

There's a container on-board with your name on it, loaded with thousands of the bronze gear blanks you've been waiting months for. To add insult to injury, you probably paid 3–4 times what this container and its contents would have cost you pre-pandemic. And that new solar energy customer that needs thousands of bronze worm gears for its panel tracking drives? Seems they've moved on.

What if there was a better way? What if you could place an order now and get those bronze gear blanks on your shop floor, ready for hobbing, while that other

shipment is still in transit? Better yet, what if your supplier could offer you a worm gear blank designed to reduce material costs by 10–30 percent? And finally, what if your supplier then offered a buyback program for those hundreds of pounds of bronze chips that you're practically giving away to your scrap recycler?

Fisher Barton's Accurate Specialties division, a Waukesha, WI-based manufacturer in bronze worm gear blanks, is making a compelling case to gear manufacturers who have seen their bronze worm gear business grow significantly in recent years. Gear engineers have long

prized bronze for its unique mechanical and chemical properties. Since it's made from a nonferrous material, a bronze worm gear won't 'scavenge' molecules from its steel mating pinion or drive worm, thus greatly reducing galling and abnormal or premature gear wear as compared to a steel-on-steel solution.

You'll find bronze worm gears wherever maintenance-free, corrosion-resistant, reliable operation is required: for the tracking systems used to position solar panels in a hostile desert environment along the Dead Sea; on boat lifts and cable and winch systems in highly corrosive marine environments; on shop



Fisher Barton uses a Zeiss scanning electron microscope to perform a very sophisticated analysis of fracture surfaces and microstructures, or a Keyence laser scanning microscope to analyze the material in 3D.

floors in the indexing and rotary tables of machine tools where an unscheduled maintenance event can cost thousands of dollars.

Cutting Material Costs

Today, this increased demand, combined with soaring copper and aluminum prices, are putting pressure on bronze alloy cost and delivery. That's why, for many manufacturers who see the benefits of bronze worm gears for their application, *composite* bronze worm gear blanks make economic sense.

For many gear blank applications, with OD diameters from as small as 3 in. to as large as 24 in., up to 75 percent of the bronze alloy can actually be replaced through a composite solution. In most worm gear applications, the bronze rim portion is all that's needed to achieve the desired wear results; the hub portion that mounts to the mating shaft can generally be made from a much less costly, but highly functional alternative material such as ductile or grey iron. Since the per-pound cost of bronze alloy today is five to seven times more than that of iron, cost savings can be truly significant, particularly as volumes go up.

In addition to greatly reducing material costs, this composite solution offers significant benefits versus worm gear assemblies, where a steel hub is turned from bar stock and assembled with screws to a bronze rim. This approach adds many more components to the supply chain, inventory, and time-consuming and costly machining and assembly process steps. Instead, a composite solution uses a cast iron hub with a bronze alloy rim poured around the hub. The process eliminates multiple turning, sweating and assembly process steps. This, combined with the reduction in material costs, can lead to a per piece reduction of anywhere from 10

Furnace Solutions for Atmosphere and Low Pressure Carburizing (LPC)

Allcase®

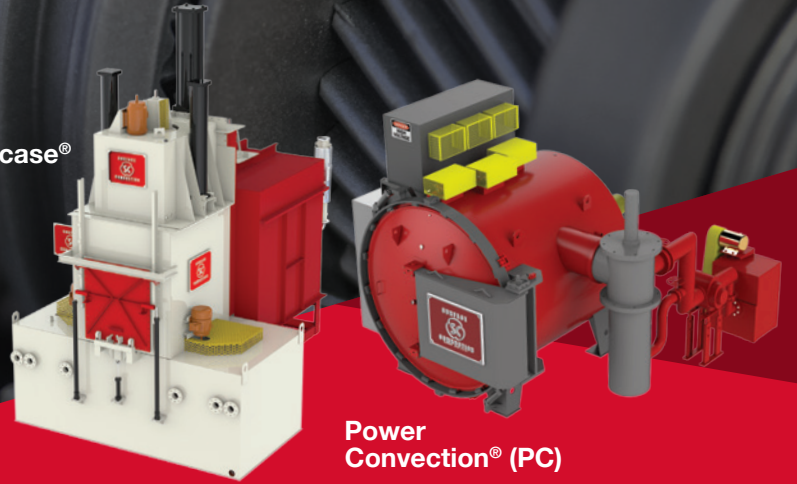

Power Convection® (PC)

Surface is Your Source.

 Surface Combustion

info@surfacecombustion.com | 1-800-537-8980 | surfacecombustion.com

60 Years Trusted

ROBOTICS • AEROSPACE • DEFENSE • TRANSPORTATION • MEDICAL

When high torque gear failure is not an option, engineers call on Spiroid.

Spiroid's skew-axis, high torque gears enable world-class power density in a small footprint.

SPIROID
HIGH TORQUE GEARING



Learn more at: SpiroidGearing.com • 320-762-7133

to 30 percent on average. The savings, particularly as volumes increase, easily offsets the casting die and pattern investment. This cost is further minimized with the ability to produce these dies to the most precise dimensions and tolerances in-house.

Most importantly, the composite gear blank is considerably more robust and reliable than its assembled equivalent. This results from the cooling bronze after casting. As it solidifies, the bronze alloy rim shrinks slightly, forming a compressive mechanical bond around the iron hub. The hub also has lugs configured into the area over which the bronze rim is poured, assuring a much stronger bond than possible with screws under torque — and eliminating the possibility of assembly screws becoming loose and resulting in gear maintenance, repair, or failure downstream. Furthermore, where a keyway is required, the cast iron hub is an inherently stronger solution than the bronze alloy equivalent.

Of course, composite gear blanks are not a one-size-fits-all solution. The iron (or, in some cases, steel) hub and bronze alloy must be carefully designed so that the compressive load created by the shrinking bronze doesn't crack the

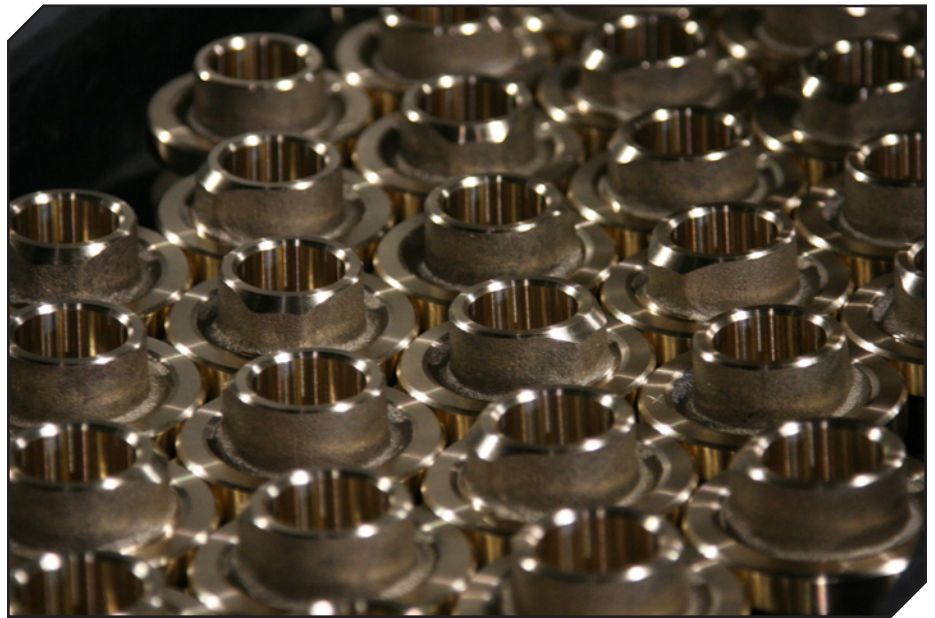

To meet the increase in gear blank demands, Fisher Barton has added six new 36 in. centrifugal casting machines, eight advanced Doosan CNC machining lathes, a versatile new Haas vertical milling center — and a new clean room for machining.

iron hub. This will vary depending on the bronze alloy used. Tin bronze, for example, works particularly well, while aluminum and manganese bronze alloys are more challenging. The provider should have a deep understanding of metallurgical properties and proprietary pre-melting and pour management techniques are critical to optimizing

performance. It also beneficial if you can machine the gear blanks in-house so they arrive ready-to-hob.

For worm gear applications where a composite solution isn't desirable, there are a variety of other bronze gear blank solutions to accommodate a wide range of application requirements. These include:

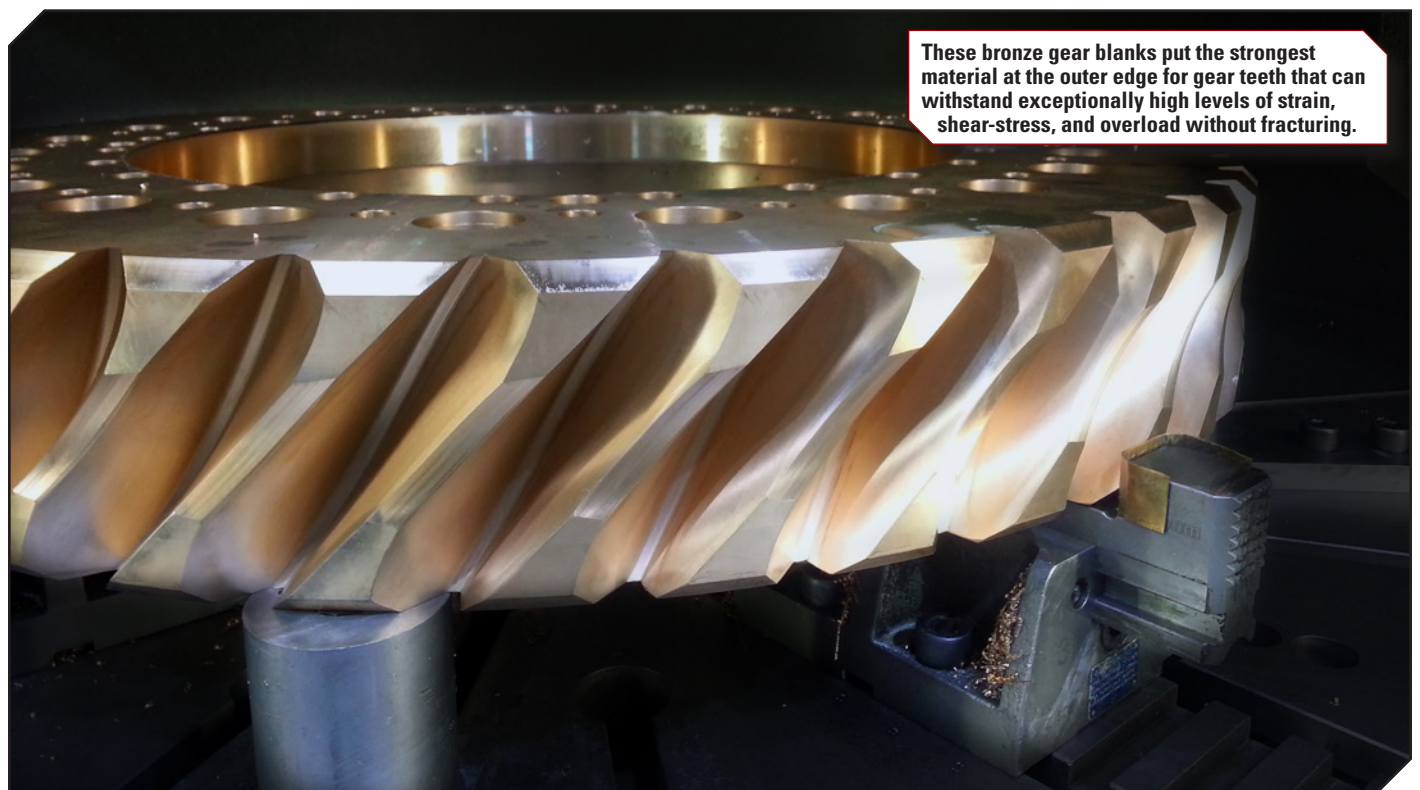

These bronze gear blanks put the strongest material at the outer edge for gear teeth that can withstand exceptionally high levels of strain, shear-stress, and overload without fracturing.

- **Centrifugal casting** ensures uniform purity, weight, density, and quality throughout the gear blank. These bronze gear blanks put the strongest material at the outer edge for gear teeth that can withstand exceptionally high levels of strain, shear-stress, and overload without fracturing. Sizes range from 2 to 50 in. dia., up to 5,000 lbs.; one-off or in quantities in the thousands.
- **Chilled casting** produces a bronze gear blank with fine grain structure and outstanding uniformity throughout. This produces chill cast bronze gear blanks at near-net-shape.
- **Continuous cast bar blanks** are made with an alternative casting method that is particularly competitive when applied to simple, low feature gear blank designs. The continuous cast process allows for part-specific casting, where simple features can be continuous cast into the raw material, thus providing a “near net” shape. High-speed in-house production flow is equipped to cut bars into pucks, then lathe-turn them into gear blanks or shafts at the speeds needed to meet higher volume requirements and Just in Time turn-around.
- **Shaft manufacturing**, from any standard ferrous and nonferrous material, with ODs to 6.875 in. and lengths to 19 in., for gear shafts, propeller shafts, drive shafts and countless other applications. Cut lengths and complete machining all done in-house with late-model, highly productive CNC turning and machining centers. Advanced wear resistant materials, including hard metals, carbides, and metal oxide ceramics are engineered into highly resistant coatings for critical shaft sealing locations.

Alloy Chip Credit Program

As bronze has become more valuable as a commodity, so too has its scrap value, in the form of the volumes of chips produced during hobbing, shaping and other machining. Yet, the prices that gear manufacturers receive from their traditional metal scrap recyclers doesn't reflect its true value.

Accurate Specialties' Chip Credit Program offers a strong incentive to instead direct this 'waste stream' of chips back to us. We pay customers 90 percent of the market value of the alloy as a credit to their account. We then clean the chips of grease and oil and return them directly to the foundry for melting and re-use as blanks. The program

is today accounting for approximately 20 tons of recycled bronze alloy per year. Our customers also benefit from the savings that result from our inventory management programs, all designed to reduce their raw material and machining costs.

Sourcing Blanks

Fisher Barton is a metallurgical innovation partner for high wear and cutting components. Engineers understand the behavior of material and the application of proprietary heat treating and surface engineering solutions that reimagine a component's lifespan beyond the core manufacturing capabilities of stamp-



The continuous cast process allows for part-specific casting, where simple features can be continuous cast into the raw material, thus providing a near-net shape.

ing, bending, forming, cutting, welding, machining and casting. These capabilities offer more than just a foundry and machine shop. 

fisherbarton.com/gears

"WE MANAGE COST AND UPTIME WITH EXPERT SPINDLE REPAIR"

Bearing wear is the leading cause of grinding spindle failure.

Signs Bearings Are Failing:

- Experiencing vibration and chatter on parts
- Final part finish unacceptable
- Tolerances are not met

PDS Advantages:

- No fees for root cause failure analysis and spindle repair quote
- Standard repair services completed in 3-5 business days
- Emergency service available

BE THE #SHOPFLOORHERO



Spindle Repair
Rebuilds • Retrofits
704.922.1206
www.SpindleRepair.com



Sharpening Services

- Hobs
- Milling Cutters
- Shaper Cutters
- Shaving Cutters
- Broaches

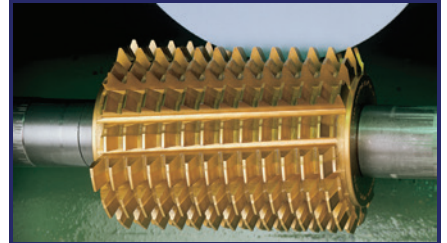

Service Centers

Hoffman Estates, IL
Phone: 847.649.1450
Fax: 847.649.0112

East Tawas, MI
Phone: 989.362.0414
Fax: 989.362.2720

Querétaro, Mexico
Phone: 52 442 217 34 45
Fax: 52 442 217 34 46



sales@star-su.com
www.star-su.com

Gears for the toughest machines on earth.

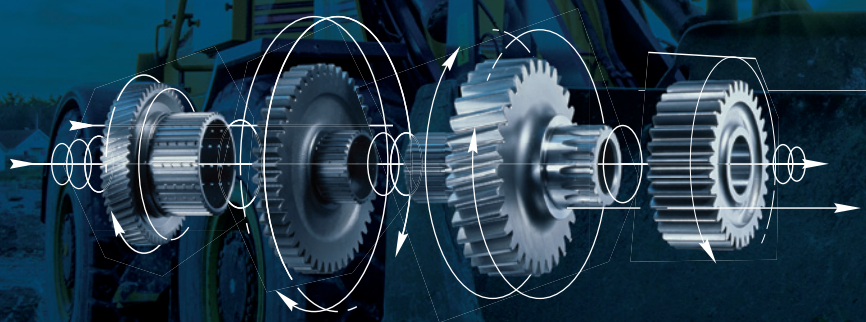

Together, we are the force that moves the world.

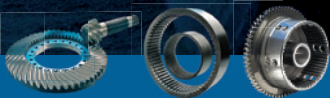

We offer a wide variety of manufacturing capabilities covering almost the entire powertrain and driveline applications.

We make available one of the widest production capability for custom gears for heavy duty vehicles of the entire industry to enable our O.E.M. Customers to focus more on their projects.

IATF 16949 and ISO 14001 Certified



CATTINI NORTH AMERICA
www.cattinina.com
Pedetemptim sed incessanter®



GEARED TOWARD SUCCESS

GEAR RESEARCH AND TESTING SPECIALISTS

An ASME, AGMA Institute at Penn State

gearresearch.org

Aaron Isaacson | 814-865-5832
aci101@arl.psu.edu



PennState
Applied Research Laboratory

High quality, precision-forged components supplied as forged or finish machined to customer specification



Cramlington Precision Forge Ltd



OUR PRODUCT RANGE

- Differential gears and pinions
- Heavy-duty bevel gears
- Curvic® / Helical / Bevel gears
- Precision forged clutches
- Curvic® clutches
- Drive couplings



cpfl-tvs.com



+44 (0) 01670 716811



enquiries@cpfl-tvs.co.uk



Custom Engineering, Prototype Work, Precision Machining, Assemblies and Standard Components

www.nordex.com

Your online source for Gears, pulleys, shafts, bearings, couplings, fasteners, custom gear boxes,



Sales@Nordex.com Eng@Nordex.com 203-775-4877

ISO9001:2015 & AS9100D, ITAR Registered, NIST.SP800-171R1, Trace Certified, Class 100 clean room

Manufacturing sMart

is your resource for the latest in great ideas from our advertisers. Check this section every issue for sMart Engineering ideas and technology.

For information about advertising, contact Dave Friedman at

(847) 437-6604

or

dave@geartechnology.com.

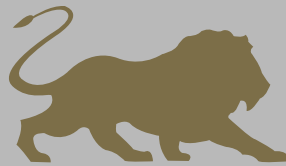

HobSource Inc

Custom gear cutting tools

**Performance
Dependability
Value**

866.HOB.TOOL

www.hobsource.com



WE'RE CERTIFIABLE

Our ISO 17025 A2LA Laboratory is available to certify or recertify your Master Gears and Spline Gauges or Contract Inspection of your gears.

Our rapid turn-around service minimizes the "out of service" time.



PENTA GEAR METROLOGY

6161 Webster Street, Dayton, Ohio 45414

937-660-8182

sales@pentagear.com

www.gearinspection.com

High-Speed Invitation

Phillip Olson, Director, AGMA Technical Services

AGMA wants you to be involved in standards development!

AGMA is in the early planning stages for a comprehensive review, and possible revision, of the widely popular high-speed gearing standard, *ANSI/AGMA 6011: Specification for High-Speed Helical Gear Units*. *ANSI/AGMA 6011* covers the special requirements in design, rating and application of enclosed helical gear drives where pitch line velocity exceeds 35 meters per second or rotational speeds exceed 4,500 rpm. If you manufacture or purchase gearboxes at those high speeds, you are a stakeholder in the industrial high-speed gearing industry. To help with this undertaking, and to maximize consensus throughout the industry, AGMA is inviting participation from all stakeholders in the industry.

The primary aim of the review is to ensure that *ANSI/AGMA 6011* continues to provide the industry with the latest industry-accepted, state-of-the-art practices. Specifically, this committee will consider the standard's compatibility with the newly published sixth edition of *API Standard 613: Special-purpose Gears for Petroleum, Chemical, and Gas Industry Services* in conjunction with proposed changes to *AGMA 923: Metallurgical Specifications for Steel Gearing* and *ANSI/AGMA 2101: Fundamental Rating Factors and Calculation Methods for Involute Spur and Helical Gear Teeth*.

Interested stakeholders will be invited to a virtual meeting to determine the project scope, outline the project milestones and assess the project feasibility. For more information and to be registered as an "interested stakeholder," please contact the AGMA technical division at tech@agma.org before May 15.

Behind the scenes of almost every good and service, there are standards showing the industry how to make superior products. Standards provide a common language, document years of collective experience on proven and verified practices, and are the generally accepted rules, guidelines and requirements

within an industry. In the United States, the stakeholders are in the driver's seat of standards development. Those who will use, and are affected by, a proposed standard are the ones tasked with writing it. Standards development is a democratic, free and open process that requires consensus before publishing. After publication, a standard's fate rests with customers and suppliers to mutually, and voluntarily, agree to the adopt the standard.

For over 100 years, AGMA has been the facilitator for the development of American gear standards. For AGMA to make gear standards the best they can be, everyone in the industry needs to be involved. When AGMA standards-writing technical committees have open projects, they meet approximately six times per year for two-hour virtual meetings, and approximately once per year for a two-day in-person meeting.

ANSI/AGMA 6011-J14
(Revision of ANSI/AGMA 6011-103)
Reaffirmed December 19, 2019

American National Standard
Specification for High
Speed Helical Gear Units

ANSI/AGMA 6011-J14

Committee meetings are a great place to network and collaborate with experts in the field, broaden your knowledge, capture technical expertise in writing, refine the standards you use and see how your influence helps shapes best practices throughout America and around the world.

From a company perspective, being involved in standards development saves time and money in a variety of ways, including reduction of redundancy, improved quality and safety, and better focusing of R&D resources. Also note that if your company's not at the table helping to write the latest standards, the standards that affect your business will be written by your competitors. For the health of our industry, please reach out and make your experience a part of this living record. 

Our Librarian Will Never Shush You

at the **GT LIBRARY**



That's because the MICHAEL GOLDSTEIN GEAR TECHNOLOGY LIBRARY is all online and you can visit it anytime. Just go to www.geartechnology.com and use the search box for access to 36 years of technical content focused on gears.

- **Every issue since 1984**
- **More than 2,000 technical articles**
- **More than 6,000 archived news items**

Addendum, Publisher's Page, Back to Basics and more

And the best news of all? You don't even need a library card. That's because the GT LIBRARY is open to everyone. Knowledge is free. All you have to do is go and get it.

www.geartechnology.com

Relationship Building – The Critical Component of Success

Joe Arvin

In the manufacturing business, there are a great number of variables that factor into the formula for success. I'm sure all would agree on the basics, including competitive capabilities, quality and pricing. Obviously, you must have a well-equipped facility, good people and efficient systems. However, I'd like to suggest that there is another variable that must not be overlooked.

To make my point, let me share a story from my days as president of Arrow Gear Company. Note that the names may have been changed to protect the innocent.

Our second largest customer had been with us for over 30 years. Even though our inside salespeople had weekly communication with them, Gary, my VP of sales, was there three to four times

a year, and I was there a minimum of twice yearly. As going there was a somewhat involved trip, requiring air travel, renting a car and an overnight stay, I felt this was an adequate level of contact.

One day, Gary came into my office and told me that he had been informed that we would be losing almost all of our work from this customer.

Shocked, I asked him, "Why? What happened?"

"I don't know," Gary responded. "Bob, the director of purchasing, just said he was sorry, but the decision had been made. Next year we will be losing the majority of their business."

That afternoon, arrangements were made for Gary and me to fly there the next day.

When we were in Bob's office, I had the chance to ask him my burning

questions.

"Bob, we've been your major gear supplier for over thirty years with no gear failures, so I thought everything was going well. Is it our quality, price or delivery? What can I do to keep your business?"

Bob responded by saying, "I'm probably telling you more than I should, but here goes. You visit us about two or three times per year?"

"That's right," I answered.

"Here's the thing, Joe," he continued. "Your competition is here three to four times every month. They have dinner with my purchasing people and our engineers, as well as some of the executives. It turns out that their prices were just a little less than yours. So, the brass said to change suppliers."

Hoping to appeal the decision,



I pleaded, “Bob, what if we lower our prices?”

“I’m sorry, Joe,” he replied. “The decision’s been made.”

We had the best equipment to produce their parts, our quality was good, delivery was on time, and I thought our prices were acceptable. Even so, I learned a valuable lesson that day. I had overlooked the critical component of building and maintaining strong relationships. In the years that followed, I never forgot this important part of the formula for success. You may be hardwired with a customer, or think that you are, but working to maintain that relationship is something that you must not lose sight of.

Following are some ideas you can use for building and optimizing relationships to enhance the success of your business.

Visitation

As the previous story suggests, you need to visit your major customers as often as possible. To make the most of your efforts, you should have a formal strategic visitation timetable. You may be thinking, “Oh, come on Joe, we have over 500 customers and all of them are important.” Obviously, visiting that many customers is not feasible. If this is the case, you need to carefully develop a prioritized list which focuses on those that are the most critical. And whenever it is logistically feasible, visit others on the same trip. Also, send marketing updates to all your customers at least once per quarter.

Something to keep in mind is this: As we go through life, the strongest friendships we forge are based on mutual experiences. While I’m not suggesting that you go on vacation with your major customers, spending face-to-face time in meetings and informal settings like having dinner will go far in accomplishing the goal of building the relationship.

The Gatekeeper

Most of the people you will be trying to establish contact with will have a gatekeeper. This could be someone in reception or perhaps an administrative assistant. Whenever possible, try to have a relationship with the gatekeeper. Be sure they know your name and that you know theirs as well. Take interest in them as a person. Of course, you always need to be sincere. Being fake about showing interest is something people can usually spot a mile away and this disingenuous sales technique will not yield benefits. I recall one of our sales representatives who always took candy or other small gifts for the gatekeeper, which was always appreciated and helped to solidify the connection.

The Purchasing Agent

Since the purchasing agent holds the keys to the purchase orders, this is definitely someone you obviously will want to be closely connected with. However, keep in mind that some companies, particularly the large corporations, tend to change buyers every few years. This is a technique used to try and prevent the buyers from becoming too friendly with the suppliers and leading them to be less hard-nosed on getting the best prices. So, keep close contact with the buyer, and if that person is replaced, be sure to visit with their successor as soon as possible. A word of warning here is that a new buyer may press you to lower your prices right off the bat, as they will want to prove themselves in their new position. Forming a relationship early on can only help you during any required negotiations.

Going Beyond the Purchasing Agent

While the purchasing agent plays the critical role of issuing the purchase order, it is almost certain that he or she is ordering components specified by the company’s engineers. For this reason, if at all possible, try to make contact with

the right people on their engineering team. If you are also able to connect with someone on their executive team, this would be a plus.

Entertainment

Meeting customers in their office is always worth the effort. However, it is entirely different to meet with them in a more informal atmosphere like lunch or dinner.

As mentioned before, try to go beyond the purchasing agent when making your invitations for entertaining, including others who are higher up in the organization whenever possible.

I have to say that I have learned more about my customers over lunch and dinner, or while sharing a drink. This informal setting is simply more conducive for an open conversation, which is essential for building a relationship.

Speaking about entertaining the customer, this reminds me of a story. Phil had recently joined our company as a sales representative. After about a year of visiting our US customers with an experienced salesman, three individuals from one of our foreign customers came for a visit. Being that Phil was the only one available, he was asked to take them to dinner. The next morning I asked Phil how the evening went. His response was that all went well and then added that he was able to save some money. Curious and caught somewhat off-guard, I asked him what he meant by this. He then told me that he took them to a fast-food restaurant. My first impulse was to throw him out of my office. This customer was worth \$5M a year to us. Had he spent \$1,000 at the fanciest restaurant in town with the most expensive wine, I would have commended him on a job well done.

Suppliers

When it comes to building relationships, don’t forget about your suppliers. These are your strategic partners, and you want to have strong relationships

with them, just as you would with a customer. If they also happen to be a supplier to your competition, that's even better.

It is surprising what you can learn from your suppliers. When I was plant manager, I would often take our major suppliers out for dinner. Later, after becoming president, I still took the opportunity to go out to dinner with them. One day my secretary asked me why I spent these evenings with vendors. I replied that I can learn more about our competitors than through any other source.

Associations

I highly recommend becoming an active member in all the applicable trade associations. For those of us who are involved in the gear industry, we have the American Gear Manufacturers Association (AGMA). My connection with the AGMA has been highly valuable over the course of my career. In addition to the technical resources they provide, they offer the opportunity to meet with your competitors.

Now you might be thinking, "Are you crazy Joe? Why do I want to get all chummy with my competition?" Let me explain a few points from my experience.

It is important to not view your competition as necessarily the enemy. Take this opportunity to learn about what they do, how they function, and their strengths and weaknesses. At an industry function, you may want to buy them a drink or even buy them dinner, getting to know them personally. Furthermore, you may even invite them to visit your facility and if they take you up on your offer, they will likely invite you to visit theirs. Now, you may be thinking, "Joe, are you off your rocker?" Let me explain. What you will find, more times than not, are ways that you can help each other. Over the years, I have had many opportunities to collaborate with other gear companies for our mutual benefit.

Reporting What You Learn

As you go about interacting and building relationships with your customers, suppliers and competitors, it is important to share what you have learned with others in your organization. Many times the information you have observed can

be valuable to others in your company, positively impacting the efforts of the sales force as well as executives and their decisions.

Don't Rely Solely on Communication Technology

In today's business world and its high degree of integrated communication technology, it is easy to think that voice-mail, email, texting and even video conferencing can be used as communication channels for building relationships. I do not believe this to be the case. These tools can be useful for exchanging information about your connection with someone, but it is not a suitable replacement for meeting face to face and building a relationship.

Listening

There is an old adage that states, "I never learned anything by talking." This certainly holds true when it comes to interacting with your business network. Asking about problems and listening to the responses is not only a way to understand a person's challenges, but it aids in building the relationship. I will say that I personally need to pay more attention to this.

Partnerships

Finally, see your interactions with customers, suppliers and competitors as opportunities to find ways of working together that are mutually beneficial. Particularly as it applies to your customers, don't just be focused on promoting what you have to sell. Instead, be sure to communicate that you are interested in being a partner to help them meet their challenges and achieve their goals.

A Final Word

If you have any questions or comments, I would look forward to hearing from you. Also, if you missed any of my previous articles, here is a list of them by issue number and page. If you'd like for me to send you a copy, please send me an email or give me a call.

Business Development for the New Year

Jan/Feb 2017—Page 50

It doesn't matter how efficient your plant is!

What matters is the accuracy of your quote?

Mar/April 2017—Page 54

Can Lean Manufacturing Kill Your Job Shop?

A Tale of Two Companies

May 2017—Page 42

You Cannot Rely on Labor Efficiency Reporting!

July 2017—Page 48

The Valued Troublesome Employee

To Terminate or Not To Terminate

September/October 2017—Page 22

Strategies for Building Your Business

November/December 2017—Page 54

Solutions for Your Process Engineer Shortage

January/February 2018—Page 48

Training - A Top Priority for Investment

January/February 2020—Page 46

That Industry 4.0 Digital Factory Thing: Part 1

August 2020—Page 24

That Industry 4.0 Digital Factory Thing: Part 2

September/October 2020—Page 34

That Industry 4.0 Digital Factory Thing: Part 3

January/February 2021—Page 46

Surviving the Labor Shortage

January/February 2022—Page 40

Joe Arvin is a veteran of the gear manufacturing industry. After 40 years at Arrow Gear Company, Joe Arvin is now president of Arvin Global Solutions (AGS). AGS offers a full range of consulting services to the manufacturing industry. His website is www.ArvinGlobalSolutions.com and he can be reached by email at ArvinGlobal@gmail.com.



Tooth Root Bending Strength of Shot-Peened Gears Made of High-Purity Steels up to the VHCF Range

Daniel Fuchs, Dr. Thomas Tobie and Prof. Karsten Stahl

Introduction

Standardized methods, like AGMA 2001-D04 (Ref. 1) or ISO 6336 (Ref. 2) for the calculation of the load carrying capacities of gears are intentionally conservative to ensure broad applicability in industrial practice. However, new applications and higher requirements often demand more detailed design calculations nowadays; for example: long operating lives in wind power gearboxes or fewer gear stages and higher speeds in e-mobility applications result in higher load cycles per tooth in a gearbox. Higher load carrying capacities in the very high cycle fatigue range (VHCF) are therefore gaining significance.

One approach to strengthen the tooth root of gears is to shot-peen the tooth root fillet. This results in higher compressive residual stresses in the tooth root area and can lead to a higher tooth root bending strength. However, a drawback is that in the VHCF range, crack initiation can often occur from below the surface at a nonmetallic inclusion. Consequently, a working hypothesis is: the higher the cleanliness, the fewer and smaller-sized the nonmetallic inclusions in the material will be, and therefore the higher the tooth

root load carrying capacity of case-hardened, shot-peened gears. This working hypothesis is verified in the framework of this publication.

Brief Overview of the State of Knowledge

Higher tooth root load carrying capacities are achievable using a shot-peening process in the tooth root fillet of gears. However, a change in the crack area characteristic can occur even up to a high number of load cycles, i.e. in the VHCF range. The crack can start in the steel matrix at a nonmetallic inclusion and lead to a so-called fisheye failure.

Fisheye Failure: Crack Initiation Below the Surface at Nonmetallic Inclusions

Case-hardened, shot-peened gears can fail due to a crack initiation below the surface at a nonmetallic inclusion. This so-called fisheye failure starts in the case of MnCr- or CrNiMo-alloyed steels (e.g. 20MnCr5 or 18CrNiMo7-6) typically at two main inclusion types: oblong manganese sulfides in MnCr-alloyed steels and spherical or oblong aluminum oxides in CrNiMo-alloyed steels (Figure 1).

Load Carrying Capacity Characteristics in the VHCF Range

In rotary bending investigations at room temperature (Ref. 3), a two-step S-N-curve is observable. The first step describes the surface fatigue limit and the surface finite life fatigue strength. The crack initiation is in this case always at the surface. In the range of higher numbers of load cycles, however, the crack mechanism changes, which leads to a second step and an internal fatigue limit. The crack occurs in the internal fatigue range in the material at a nonmetallic inclusion. Failures below the surface in shot-peened standard specimens are also documented for between 10^7 and 10^9 load cycles (Refs. 4–13).

Investigations of up to $1,0^{10}$ load cycles, which showed such failures, have also been carried out (Refs. 14, 15). Fatigue failures in the VHCF range have been documented for bearing steels (Ref. 16), nitrocarburized specimens (Ref. 17), austempered ductile iron (ADI) (Ref. 18), dual-phase steels (Ref. 19), and welded joints (Ref. 20). Murukami et al. (Refs. 21, 22), Mughrabi (Refs. 23, 24) and Bathias (Refs. 17, 25) do not specify a second fatigue limit in the range of a higher

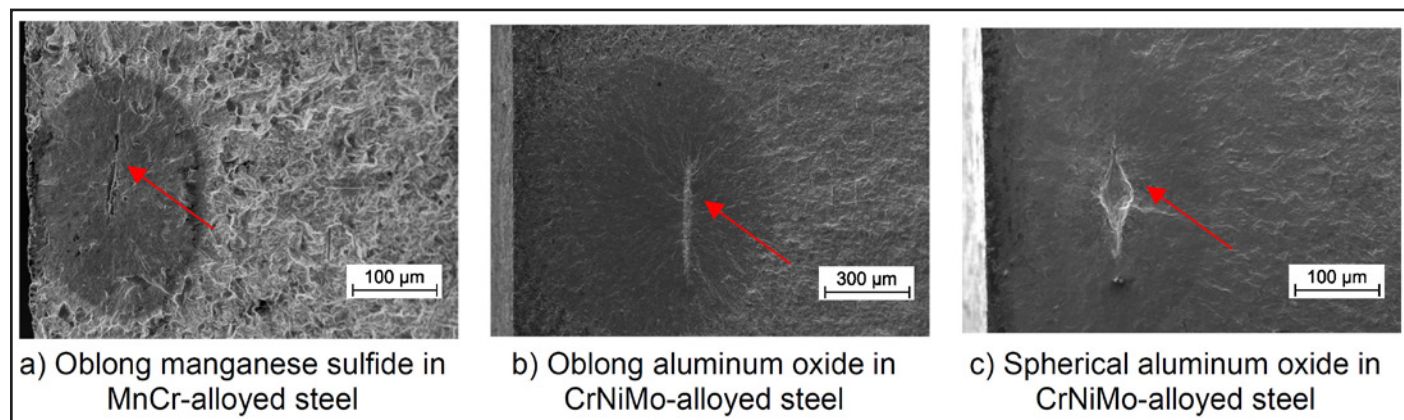

Figure 1 Typical nonmetallic inclusions in fisheye fracture surfaces of gear steels.

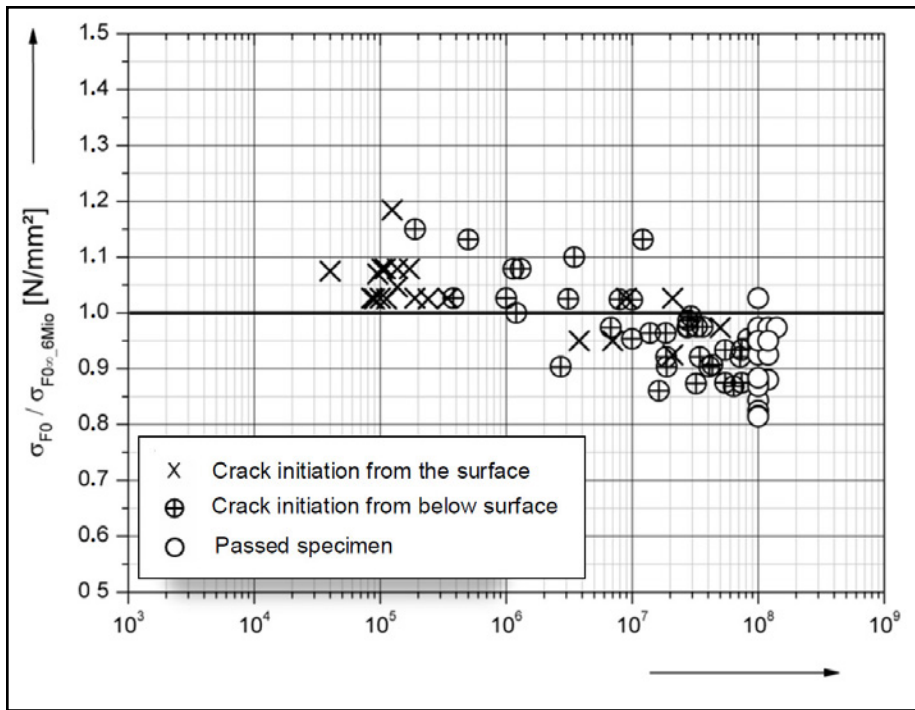

Figure 2 Summary of results of various tests with case-hardened, shot-peened gears reported in (Ref. 26, translated); (y-axis: ratio of nominal tooth root stress σ_{F0} for each test point and nominal tooth root stress for 50% failure probability at a load cycle limit of 6 million $\sigma_{F0_{\infty, 6Mio}}$ for each variant).

Variant	Material	Characterization of the heat	Casting method	Bar diameter in mm	Degree of deformation
S4	20MnCr5	Open-hearth melted	Continuous casting	105	8:1
S6		Open-hearth melted	Continuous casting	105	
S8		Electro-slag remelted (ESR)	Ingot casting	100	

Parameter	Symbol	Unit	Pinion	Wheel
Normal module	m_n	mm	1.5	
Tooth width	b	mm	8	
Number of teeth	z_1/z_2	-	59	61
Normal pressure angle	α_n	°	20	
Helix angle	β	°	0	
Profile shift coefficient	x	-	-0.13	1.19
Transverse contact ratio	ϵ_a	-	1.24	
Base diameter	d_b	mm	83.2	86.0
Pitch diameter	d	mm	88.5	91.5
Tip diameter	d_a	mm	91.5	96.0

Gear size m_n in mm		1.5
Shot-peened area		Tooth root fillet
Size and hardness of shot	1. step	StD-G3, 0.40 mm, VDFI 8001, 700 HV (Cut wire, spherical)
	2. step	Glass beads, 250 – 425 μ m
Shot density in %	1. step	1.00 – 1.25 x t 98 %
	2. step	1.75 – 2.00 x t 98 %
Intensity in mm A	1. step	0.23 – 0.28
	2. step	0.08 – 0.12

Load torque in Nm	Load-dependent transverse contact ratio	Tooth root stress* (under additional consideration of the dynamic factor K_v , acc. to ISO 6336 (Ref. 2) in N/mm ²)
130	1.30	1080
150	1.49	1213
170	1.55	1366
190	1.66	1489
210	1.69	1630
230	1.75	1773
250	1.78	1916

*Mean value over the tooth width of the tooth root stress values determined with the aid of RIKOR I (Ref. 34) and taking into account the dynamic factor $KV = 1.06$ acc. to ISO 6336 (Ref. 2)

number of load cycles. A steady decline is expected even up to 10^9 – 10^{10} load cycles.

In the case of shot-peened gears, studies by Stenico (Ref. 27, based on Ref. 28) and Bretl (Ref. 26, based on Ref. 29) display similar characteristics to those documented for standard specimens. The test results in Reference 26 show, foremost, failures due to subsurface crack initiation at nonmetallic inclusions up to 10^8 load cycles (Fig. 2). Bretl (Ref. 26, with experimental results internationally published in Ref. 30) also attests a second knee in the S-N curve for case-hardened, shot-peened gears, and even up to 10^8 load cycles a decrease in the endurance fatigue life. As a result, no second internal fatigue limit was determined. He states that the surface fatigue limit is primarily influenced by the residual stress state and that the slope of the S-N curve at a higher number of load cycles is mainly influenced by the degree of cleanliness. However, in Reference 26, only a limited number of investigations have been carried out on shot-peened gears up to 10^7 respectively 10^8 load cycles on the pulsator test rig.

Schurer (Ref. 31) builds on the results of Bretl (Ref. 26). In the framework of Schurer's work (with experimental results internationally published in References 32 and 33), extended experimental investigations on the pulsator and the FZG back-to-back test rig were performed regarding fish-eye failures in the tooth root of case-hardened, shot-peened gears. The gears were made out of steel with different degrees of cleanliness. The limiting number of load cycles was set to $15 \cdot 10^6$ (for some test points $50 \cdot 10^6$) in the pulsator tests and $30 \cdot 10^6$ or $50 \cdot 10^6$ in the back-to-back tests. In the experimental tests even up to $50 \cdot 10^6$ load cycles, tooth root failures due to crack initiation below the surface at a nonmetallic inclusion occurred. This led to a decrease in the tooth root load carrying capacity in the very high cycle fatigue range. In addition, it was confirmed that the degree of cleanliness has a nonnegligible influence. However, due to the limited number of test points, no proper differentiation between the variants could be made. In particular, no proper differentiation could be made based on the degree of cleanliness. In Figure 3, the test results of three test variants (S4, S6, and S8) on

the pulsator test rig are shown for later comparison. The test results of Schurer (Ref. 31) on the FZG back-to-back test rig are directly given in the S-N diagrams later in the publication.

Aim of the Investigation

The aim of the investigation presented in this publication was to broaden the database of the investigations of Schurer on the FZG back-to-back test rig. On the one hand, further tests were carried out and on the other hand, the limiting number of load cycles was set at $100 \cdot 10^6$ load cycles. Three variants (S4, S6, and S8) from Reference 31 with different degrees of cleanliness were chosen. Table 1 gives an overview of the chosen variants and their properties. Further characteristics are presented below, in the section on Material and Gear Characterization. The variants are all 20MnCr5 steels but have different process routes and characteristics. In the second step, based on the broadened database, a probable correlation between the experimental results and the degree of cleanliness are checked again.

The tests were performed on a so-called FZG back-to-back test rig with a center distance of $a = 91.5$ mm. The inspection interval for the tests was $2.5 \cdot 10^6$ load cycles. Test pinion and test gear are mounted on two parallel shafts. These shafts are connected to a drive gear stage with the same gear ratio. A defined static torque is applied by twisting the load clutch on the two separate parts of the test pinion shaft. Hereby, defined weights on a load lever or a bracing device are used. For the investigations case-hardened gears with a gear size of normal module 1.5 mm were used. The gear data are given in Table 2. All gears were two-staged shot-peened in the tooth root fillet to induce high compressive residual stresses. In the first stage, cut wire was used, and in the second stage, glass bead; see Table 3.

Please note: The tooth root stress values are deliberately not shown in the later S-N curve diagrams. This is due to the nonlinear relationship between the torque applied to the pinion and the resulting nominal tooth root stress. Table 4 lists the tooth root stress valid for the respective test torque.

Table 5 Chemical composition of the test variants and threshold values according to DIN EN ISO 683-3 (Ref. 35)												
Variant	Material	Chemical composition in mass-%										
		C	Mn	Cr	Ni	Mo	S	Al	Cu	P	Si	
S4	20MnCr5	0.21	1.20	1.14	0.15	0.04	0.028	0.030	0.14	0.009	0.15	
S6		0.18	1.25	1.07	0.22	0.06	0.012	0.023	0.09	0.012	0.26	
S8		0.18	1.12	1.15	0.19	0.05	0.006	0.019	0.12	0.016	0.16	
20MnCr5 acc. to (Ref. 35)		max.	0.22	1.40	1.30	-	-	0.035	-	-	0.025	0.40
		min.	0.17	1.10	1.00	-	-	-	-	-	-	-

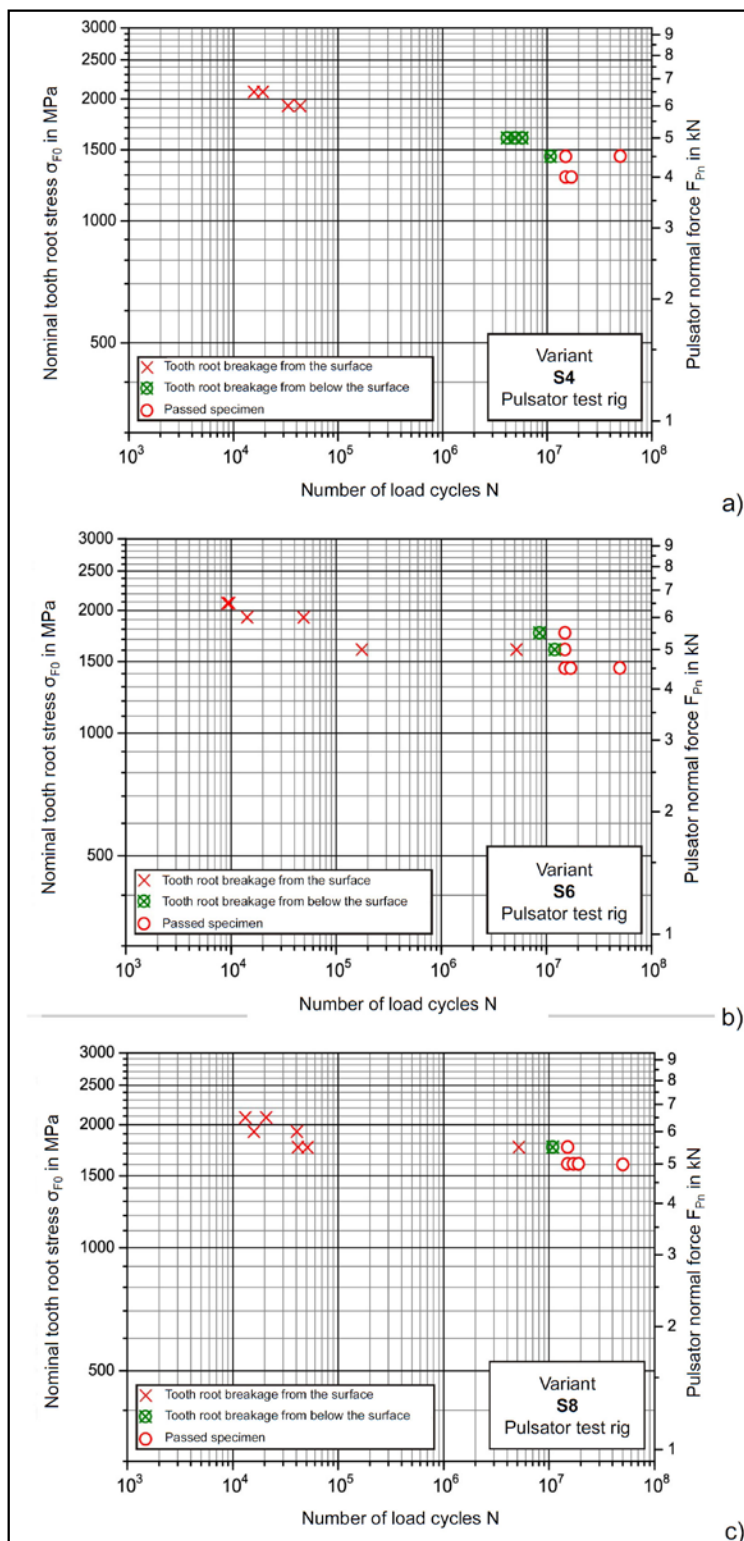

Figure 3 Test results for case-hardened, shot-peened gears on the pulsator test rig of variant a) S4, b) S6 and c) S8 made out of 20MnCr5 (gear data are listed in Table 2) (Ref. 31, translated).

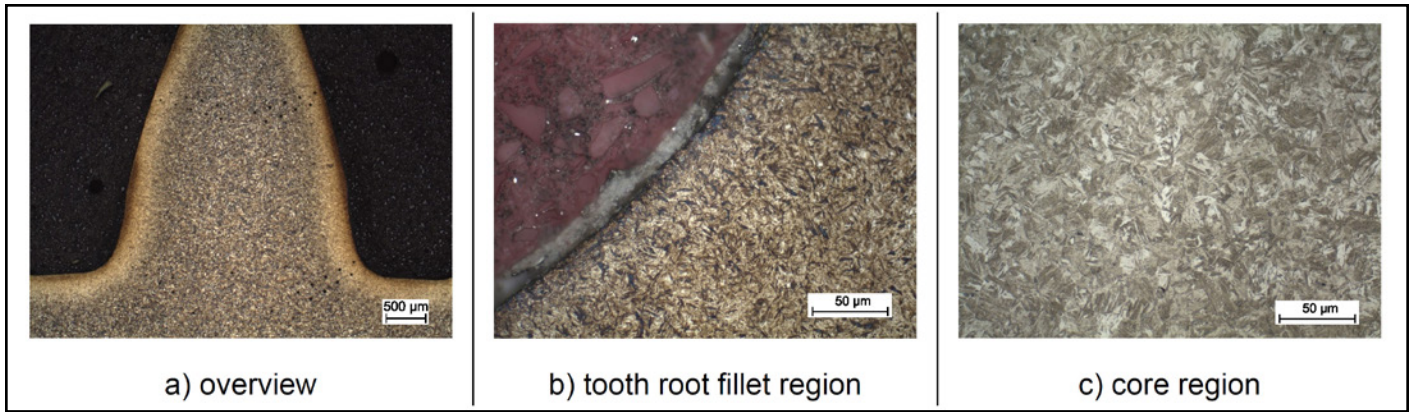

Figure 4 Microstructure of variant S4.

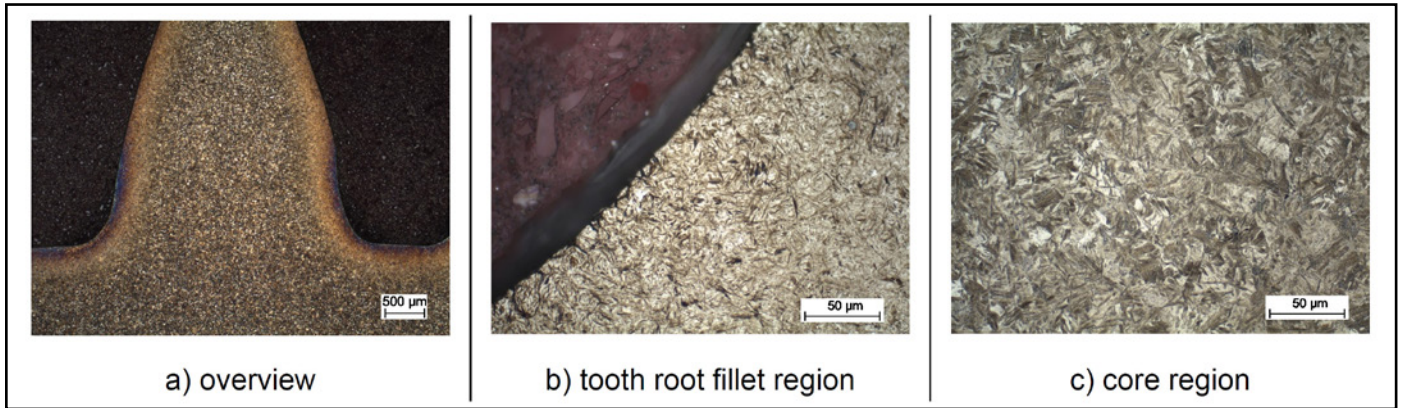

Figure 5 Microstructure of variant S6.

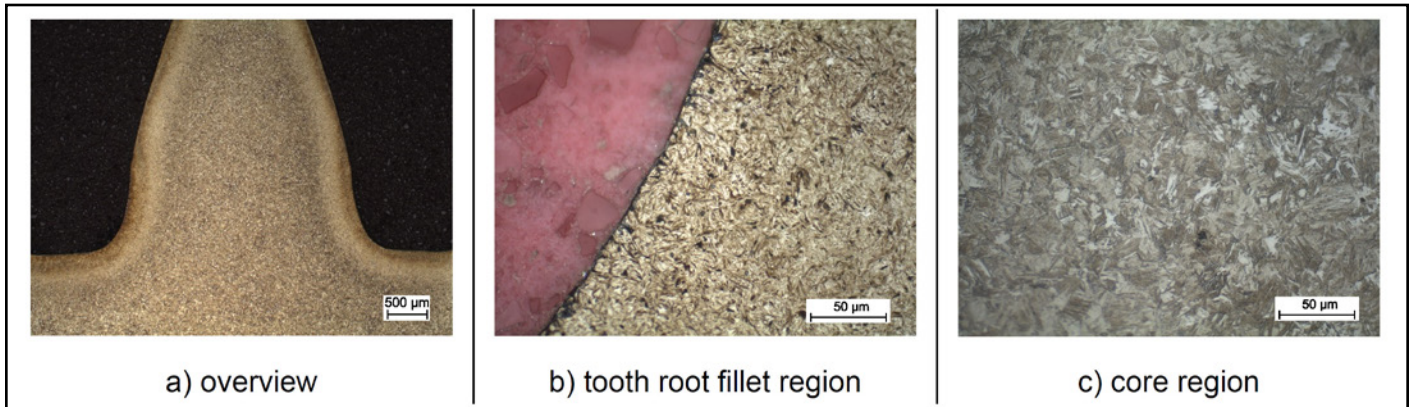

Figure 6 Microstructure of variant S8.

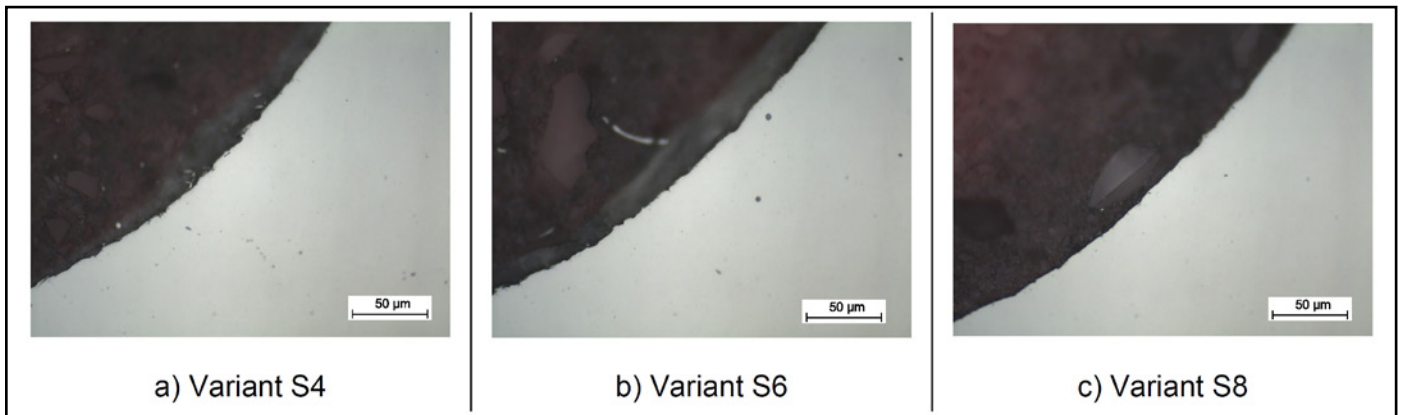

Figure 7 Surface oxidation of variants S4, S6, and S8.

Material and Gear Characterization

In the following, the material and gear characterization of the three investigated variants is presented. The chemical composition of the test variants is listed in Table 5. All three test variants are within the threshold values according to DIN EN ISO 683-3 (Ref. 35). It can be seen that there is a reduced sulfur content, especially in the S6 and S8 variants. These values are well below the threshold value. This measure taken in steel making should prevent the formation of manganese sulfide inclusions. The aluminum content is also lower in the S6 and S8 variants to prevent the formation of aluminum oxide inclusions. However, it should be noted that a certain aluminum content is necessary for fine grain stability. A reduction in aluminum content should therefore not be taken to extremes.

Figures 4–6 show the microstructures of the variants S4, S6 and S8. The microsections for the microstructure are etched with Nital. In each case on the left side, an overview is given, in the center the microstructure in the tooth root fillet, and on the right, the microstructure in the core region is shown. All variants show a smooth transition from the surface layer to the core region with lower and upper bainite in the core region. In the surface layer, variant S4 shows finely dispersed carbides and martensite, variant S6 shows a fine martensitic structure with a low content of retained austenite, and variant S8 also shows a low content of retained austenite and martensite. Figure 7 compares the surface oxidation

of all three variants, which is for all variants below 3 μm .

To sum up: All test gears show a microstructure typical for case-hardened gears and no anomalies were visible. In addition, the gears show very low surface oxidation, well below the threshold limits according to ISO 6336, part 5 (Ref. 36).

The dual shot-peening process introduces high residual stresses in the tooth root fillet. Figure 8a confirms high compressive residual stresses at and near the surface. The maximum values range between $-1,000$ and $-1,200$ MPa. The dual shot-peening process has an effective depth of about 0.15 to 0.20 mm. All three variants show a maximum for the

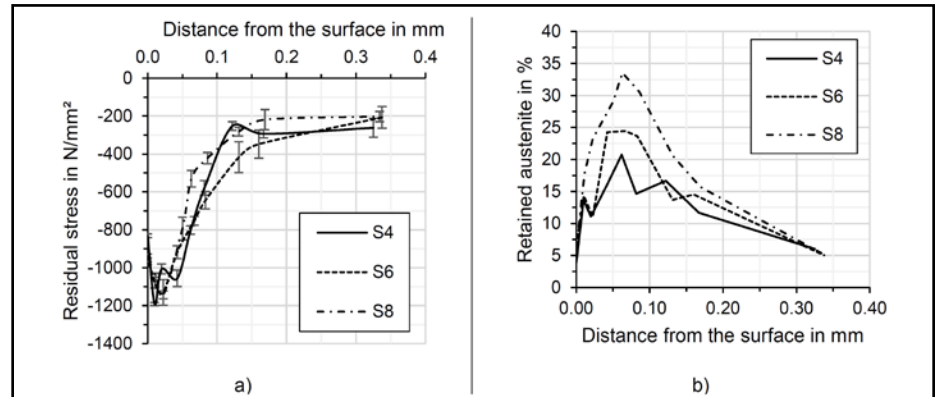

Figure 8 a) Residual stress depth curves in the area of the tooth root fillet and b) retained austenite content in the near-surface area (measured by X-ray diffractometry).

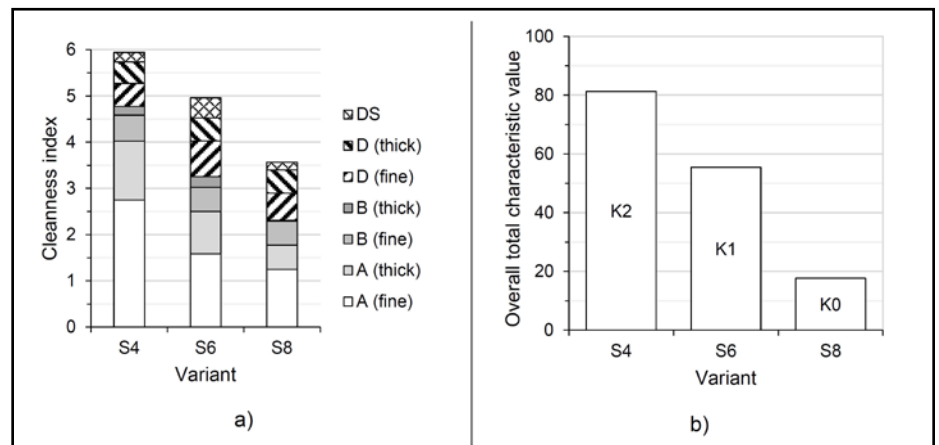

Figure 9 a) Stacked bar diagram of the cleanliness indexes according to ISO 4967, method A (Ref. 37) and b) overall total characteristic values according to method K of SEP 1571 (Ref. 38) starting from size class 0 (K0), size class 1 (K1) and size class 2 (K2).

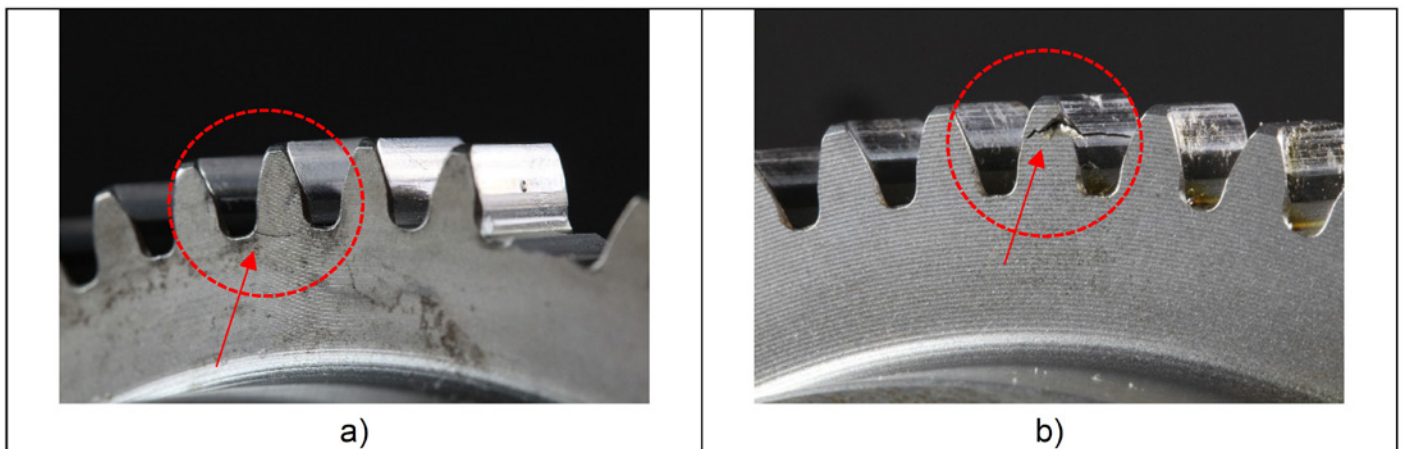

Figure 10 a) Example of a tooth root fracture with crack initiation at or below the surface in the tooth root fillet near the 30° tangent and b) example of a breakage at the tooth flank due to crack initiation at the tooth flank (observed only once each for variant S4 and S6).

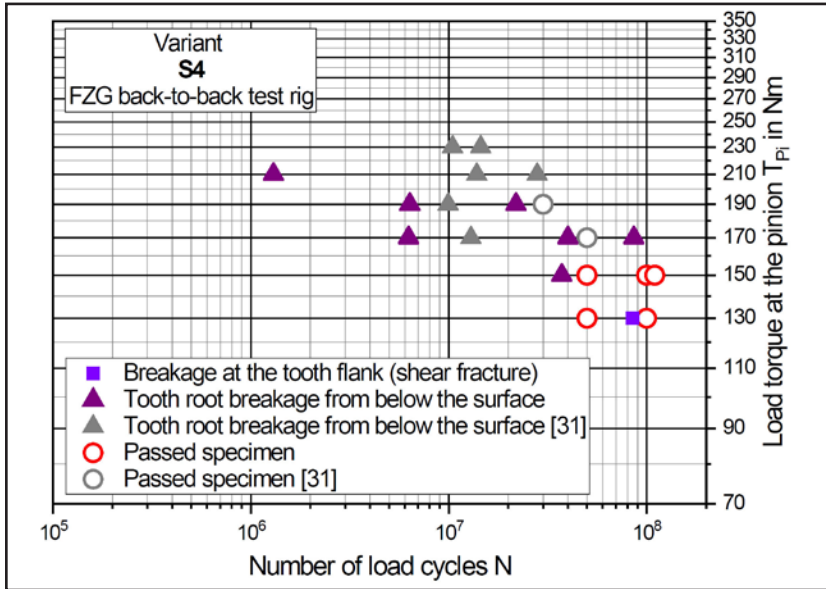

Figure 11 Test results in the range of the endurance limit of variant S4.

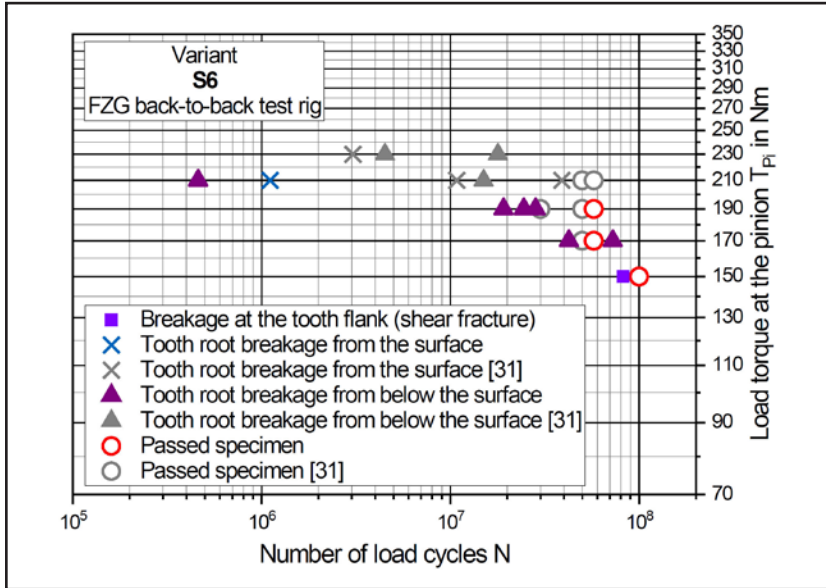

Figure 12 Test results in the range of the endurance limit of variant S6.

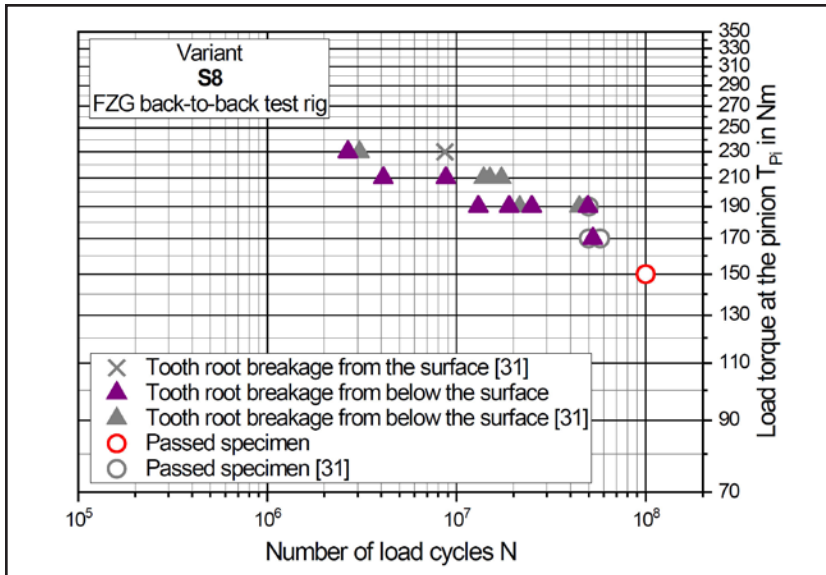

Figure 13 Test results in the range of the endurance limit of variant S8.

retained austenite in a depth range of about 0.05 to 0.10 mm (Figure 8b). Variant S8 shows the highest value for retained austenite, whereas variant S4 shows the lowest value. The nonmetallic inclusions responsible for crack initiation in these variants had a distance from the surface of 0.08 to 0.30mm. It is thus evident that all inclusions are located behind the compressive residual stress and retained austenite maxima, in the range in which the residual stresses and the retained austenite already decrease again significantly.

Figure 9 gives an overview of the degree of cleanliness. In Figure 9a, the cleanliness index for the different inclusion categories according to ISO 4967, method A is shown. Variant S8 shows the best cleanliness index, variant S6 lies in between and S4 shows the highest value and therefore the lowest degree of cleanliness. The same tendency can be seen in Figure 9b, according to SEP 1571, method K. The starting size class for method K of SEP 1571 was chosen individually for each variant based on the inclusion content and under consideration of a reasonable effort for the manual evaluation of the degree of cleanliness by a metallographer in industrial practice.

Experimental Investigations of the Tooth Root Bending Strength

Experimental results

In the following, the experimental results on the FZG back-to-back test rig are presented. The tooth flanks of the pinion show slight scrape marks at half tooth height after the test runs. This results from the shortened tip diameter of the wheel. Starting from the scrape mark, some micropitting is visible, which varies in intensity depending on the number of load cycles, the load level, and the variant. Particularly at load cycles above $50 \cdot 10^6$, surface damage on the flank is also evident, which for one test point of variant S4 and variant S6 each was so severe that it initiated a break from the flank (shear fracture); see Figure 10b. All other fractures occurred at the 30° tangent to the tooth root fillet, as Figure 10a illustrates. The crack initiation was hereby either at the surface or from below the surface at a nonmetallic inclusion.

The test points of the investigations on the FZG back-to-back test rig of Schurer (Ref.31) are colored grey in the following diagrams (Figs. 11–13), whereas the additional test points in the framework of this publication are colored differently. Variant S4 shows passed specimens on the load levels of 130 and 150Nm up to $100 \cdot 10^6$. At the load level of 170Nm a specimen reached $50 \cdot 10^6$ load cycles without failure,

whereas one failure due to a crack initiation at a nonmetallic inclusion is even at approximately $75 \cdot 10^6$ load cycles. At the load level of 130 Nm one specimen reached $30 \cdot 10^6$ load cycles. Failures due to a crack initiation at a nonmetallic inclusion are present from a load level of 150 Nm on. At variant S6 a specimen reached $100 \cdot 10^6$ load cycles without failure at a load level of 150 Nm. Further passed specimen are present on the load levels 170, 190 and 210 Nm up to $50 \cdot 10^6$ load cycles. At the load levels of 170 and 190 Nm the gears failed only due to a crack initiation below the surface at a nonmetallic inclusion. The load levels 210 and 230 Nm showed failures from below the surface as well as from the surface. At the load level of 210 Nm a failure due to a crack initiation at the surface is present at approximately $40 \cdot 10^6$ load cycles. Variant S8 shows one passed specimen at $100 \cdot 10^6$ load cycles at a load level of 150 Nm. Only one failure at the load level of 230 Nm is due to a crack initiation at the surface. All other crack initiations are from below the surface at nonmetallic inclusions. Passed specimens at $50 \cdot 10^6$ load cycles are present on the load levels of 170 and 190 Nm. Whereas at the load level of 170 Nm a gear failed due to a crack initiation at a nonmetallic inclusion just above $50 \cdot 10^6$ load cycles.

Crack Area Characteristics

Most of the failures were due to a crack initiation below the surface at a nonmetallic inclusion. Only some of the test gears failed due to a crack initiation at the surface in the tooth root fillet. The

crack area characteristic was hereby as typical for surface cracks. No fish-eye nor nonmetallic inclusion were present in this case. All tooth root fractures from below the surface showed the typical fish-eye characteristic (Fig. 14). The cracks were initiated in all cases at manganese sulfide inclusions. Minor elements of the manganese sulfide inclusions were molybdenum (Mo), magnesium (Mg), aluminum (Al), oxygen (O), and calcium (Ca). The inclusions were either stringer inclusions or oblong shaped.

Discussion and Conclusion

- Based on the experimental studies, the following can be stated:
- All variants show fractures initiated from below the surface at nonmetallic inclusions.
- The fractures from below the surface show a typical fish-eye characteristic.
- In the endurance fatigue range, only a few failures from the surface occurred.
- The usual number of load cycles for fractures from below the surface at nonmetallic inclusions is greater than $3 \cdot 10^6$, usually even greater than $10 \cdot 10^6$.
- Relatively fewer tooth root breakages are present above a load cycle number of approximately $50 \cdot 10^6$.

In the following, the experimental investigations on the pulsator test rig from Schurer (Ref. 31) are firstly compared to the extended database on the FZG back-to-back test rig from this publication. Secondly, the experimental database up to $50 \cdot 10^6$ and up to $100 \cdot 10^6$ load cycles is compared and a probable correlation between the experimental results and the degree of cleanliness is checked.

Comparison of the Experimental Investigations on the Pulsator and the Back-to-back Test Rig

In the gear running tests on the back-to-back test rig, 59 teeth are examined simultaneously in one test run. In one test run alone, this corresponds to 2.5 to 3 times the test volume compared to the complete test of the tooth root fatigue strength with the usual assignment of 10 to 12 test points in the pulsator test, in which only two teeth are loaded per test. The probability of a critical nonmetallic inclusion at a critical depth is thus much higher in the course of the gear running tests than in the pulsator tests. In addition, the limiting load cycle number was set on the back-to-back test rig to $100 \cdot 10^6$ (in the pulsator: $15 \cdot 10^6$). Both facts explain why all variants in the gear running tests showed foremost crack initiations below the surface at a nonmetallic inclusion in the endurance fatigue range. When comparing the experimental results, of course, additionally to the presented results, the known systematic differences in gear running tests and pulsator tests should also be kept in mind (Refs. 39, 40) as well as the extended, but still limited available database.

Figure 15a shows the total number of tests failed due to a crack initiation at nonmetallic inclusion in the endurance fatigue range and Figure 15b shows the percentage related to all failed tests. The tooth root fractures of variant S4, with the lowest degree of cleanliness, start on the pulsator and the back-to-back test rig in each case 100 percent below the surface at a nonmetallic inclusion. The

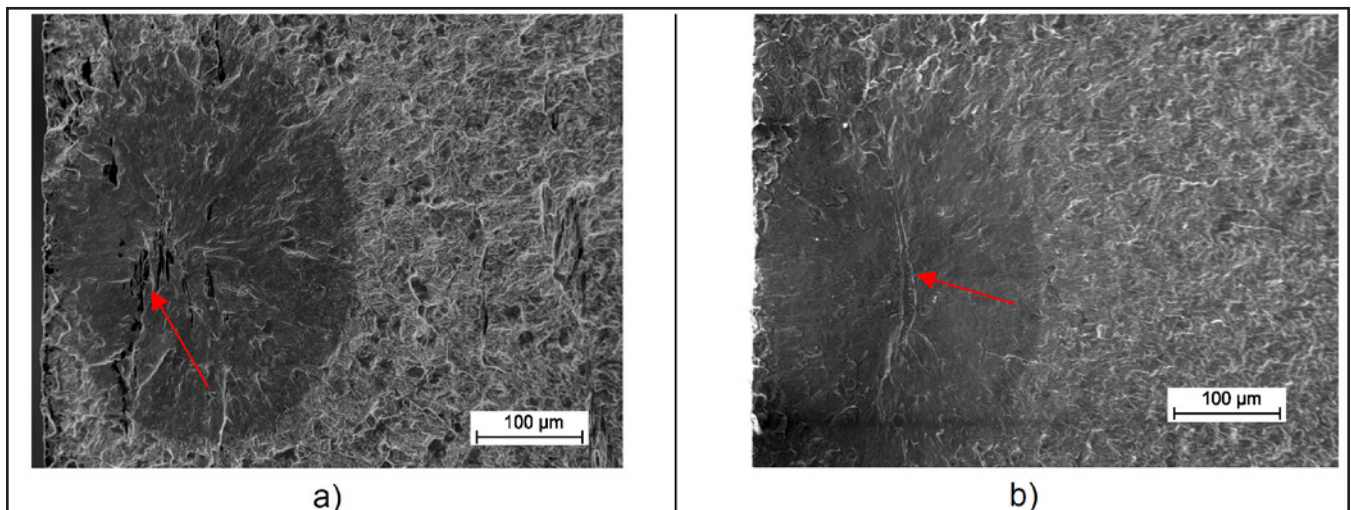

Figure 14 Exemplary a) stringer (variant S4) and b) oblong (variant S8) manganese sulfide inclusion in a fish-eye fracture surface.

number of crack initiations below the surface at nonmetallic inclusions for the pulsator tests decreases with a higher degree of cleanliness but not for the gear running tests (see Figure 15a). The greatest difference is present for variant S8.

It can be concluded that the tests on the pulsator test rig with a limiting number of load cycles of $15 \cdot 10^6$ are not fully representative for case-hardened, shot-peened gears made out of steels with a higher degree of cleanliness, and investigations on the back-to-back test rig with a higher number of load cycles could be necessary to determine more reliable results for the tooth root bending strength in the VHCF range.

Comparison of the Experimental Investigations on the Back-to-back Test Rig up to 50 Million and 100 Million Load Cycles

Figure 16 compares the evaluated endurable torque at the pinion for 50 percent failure probability for $50 \cdot 10^6$ and $100 \cdot 10^6$ load cycles. As stated before, the tooth root stress values are deliberately not used for comparison due to the non-linear relationship between the torque applied to the pinion and the resulting nominal tooth root stress (see Table 4). The endurable torque at the pinion for 50 percent failure probability was determined according to the stair case method

(Ref.41). Hereby, for the evaluation up to $50 \cdot 10^6$ load cycles, all testpoints, which had load cycles above $50 \cdot 10^6$ load cycles were evaluated as run-outs. The standard deviation was calculated according to the Probit method (Ref. 42).

For all three variants, a further decrease in the load carrying capacity with a higher number of load cycles is observable, especially for variant S6. It can be seen that even up to $100 \cdot 10^6$ load cycles no endurance limit for case-hardened, shot-peened gears can be assumed.

Up to $50 \cdot 10^6$ load cycles, variant S6, which has a degree of cleanliness between variant S4 and S8, shows the highest load carrying capacity. Therefore, with the limited database in Reference 31 and even with the broadened database in the framework of this publication, no proper differentiation between the degree of cleanliness and the tooth root load carrying capacity could be drawn up to $50 \cdot 10^6$ load cycles; compare Figure 16.

However, up to $100 \cdot 10^6$ load cycles and based on the broadened database, a correlation between the degree of cleanliness and the load carrying capacity can be drawn. Variant S4, with the lowest degree of cleanliness, shows the lowest value, whereas variant S8 with the highest degree of cleanliness shows the highest value. An increase of about 10 percent in load carrying capacity can be stated from

variant S4 to variant S8.

It can be concluded that with a higher degree of cleanliness, higher tooth root bending strengths are possible up to the VHCF range.

Summary and Subsequent Steps

The load capacity calculation for gears acc. to standardized methods, like AGMA 2001-D04 (Ref.1) or ISO 6336 (Ref.2), are intentionally conservative to ensure broad applicability in industrial practice. However, due to new applications and higher requirements, more detailed design calculations and higher tooth flank and tooth root load carrying capacities up to the very high cycle fatigue (VHCF) range are nowadays often necessary.

For example, with a grid frequency of 50 Hz, two pairs of poles and a speed of $1,500 \text{ min}^{-1}$ are required in a wind generator. Common rotor speeds are 14 or 30 min^{-1} and a common gear ratio is 1:100. This results in the gearbox of a wind power plant with an assumed operating time of 30,000 h in approx. $2.7 \cdot 10^9$ loadcycles at the pinion on the input shaft of the transmission (Refs. 43, 44). For an assumed lifetime of 5,000 operating hours of a passenger car and an assumed input speed of the electric motor of $16,000 \text{ min}^{-1}$, load cycles in the range of $4.8 \cdot 10^9$ also result at the pinion on the

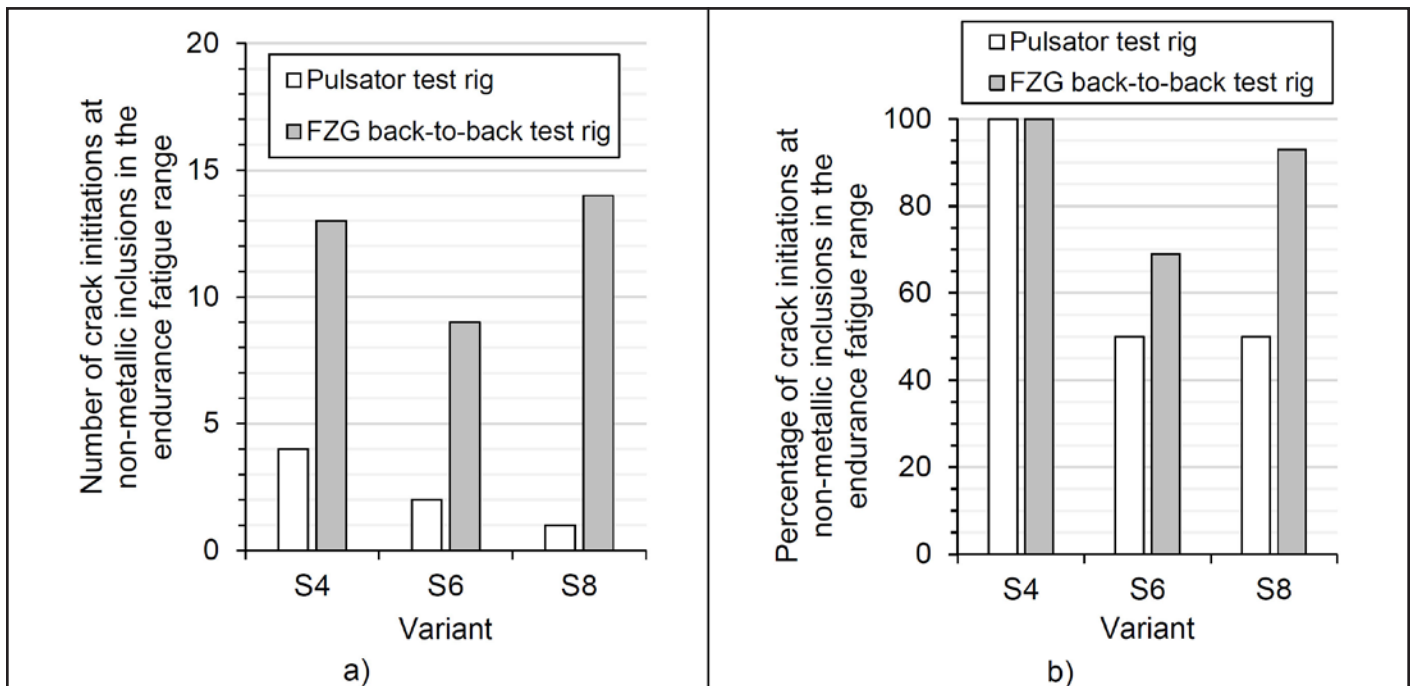

Figure 15 a) Number and b) percentage of crack initiations at nonmetallic inclusions from below the surface in the endurance fatigue range for tests on the pulsator and on the back-to-back test rig (Results of the pulsator tests are shown in Figure 3 and are taken from Reference 31).

input shaft for today's e-mobility transmission concepts (Ref 45).

To achieve a higher bending strength in the tooth root area of gears, one approach is to induce increased compressive residual stresses into the stressed area, e.g. by a shot-peening process. The drawback is that often there is a change in the crack mechanism. The crack initiation can now occur preferably at nonmetallic inclusions in the steel matrix.

As a result, the working hypothesis of this publication was: the higher the cleanliness the fewer and smaller sized the non-metallic inclusions in the material and therefore the higher the tooth root load carrying capacity of case-hardened, shot-peened gears. This working hypothesis was verified with tests on FZG back-to-back test rigs up to the very high cycle fatigue (VHCF) range (up to $100 \cdot 10^6$ load cycles). The test gear variants were manufactured from steels with a different degree of cleanliness.

The main conclusions of this publication are:

- All variants, even with a high degree of cleanliness (ultra-clean gear steels), show fish-eye fractures initiated from below the surface at nonmetallic inclusions and result in a decrease in tooth root bending strength.
- Tests on the pulsator test rig with a limiting number of $15 \cdot 10^6$ load cycles are not fully representative for case-hardened, shot-peened gears made out of steels with a higher degree of cleanliness, due to the limited investigated material volume, and investigations on the back-to-back test rig with a higher number of load cycles could be necessary to determine more reliable results for the tooth root bending strength in the VHCF range.
- With a higher degree of cleanliness, higher tooth root bending strength numbers are possible up to the VHCF range taking into account the different crack mechanism.

The database for the tooth root bending strength between $50 \cdot 10^6$ and $100 \cdot 10^6$ is still very limited on the FZG back-to-back test rig. Therefore, further investigations into gears should concentrate in particular on the range between 50 and 100 million load cycles. In addition, experimental tests above $100 \cdot 10^6$ load cycles should be performed to further expand the database and to check if a second endurance fatigue limit is

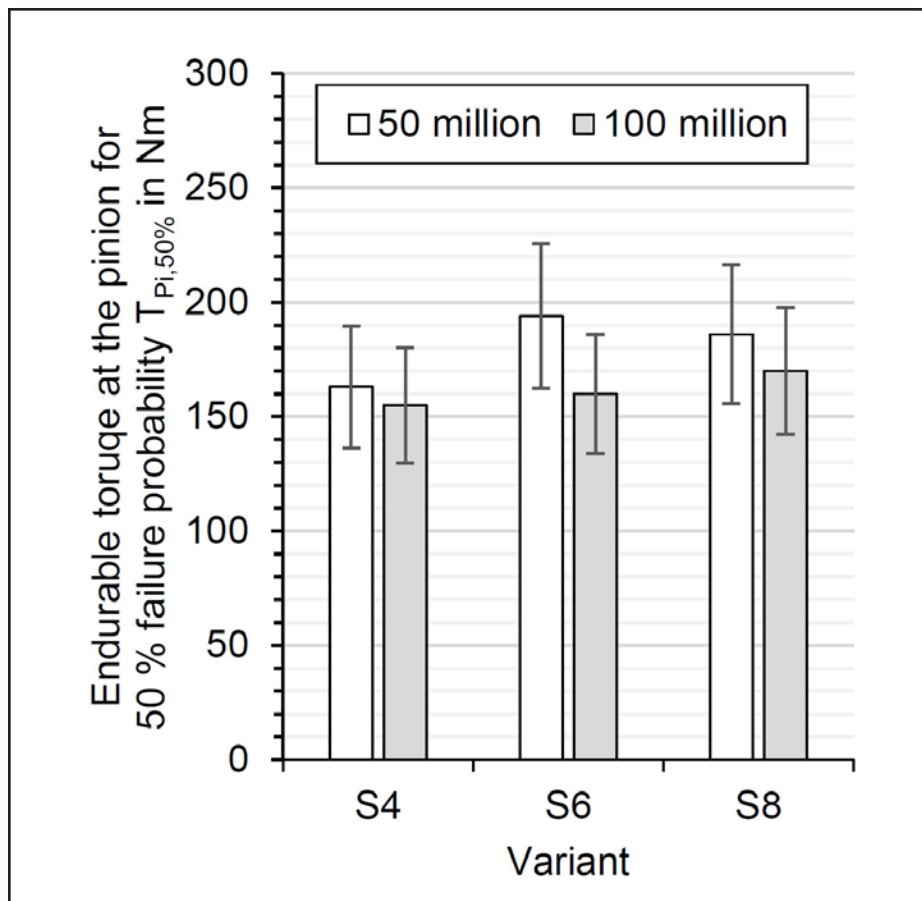

Figure 16 Comparison of the endurable torque at the pinion for 50% failure probability and standard deviation acc. to the Probit method (Ref. 42) for a limiting number of load cycles of $50 \cdot 10^6$ and $100 \cdot 10^6$.

to be expected at a higher number of load cycles. However, it was also shown that with a higher number of load cycles, damage on the tooth flank can occur and can lead to a fracture. As a result, no tooth root bending strength can be determined. This should be kept in mind when performing such tests with a higher number of load cycles.

Furthermore, it has to be noticed that the presented characteristics of a stepwise S-N curve only apply to case-hardened, shot-peened gears with high compressive residual stresses at and close to the surface. For unpeened or shot-blasted case-hardened gears with lower compressive residual stresses, comparable investigations prove that the tooth root bending strength is dominated by cracks initiated at the surface and that these surface cracks typically occur at load cycle numbers below $3 \cdot 10^6$. ⚙️

Acknowledgment

The underlying research work (Ref. 31) was funded in equal proportions by the "Arbeitsgemeinschaft industrieller

Forschungsvereinigungen e.V. (AiF)", the German Federal Ministry of Economics and Technology (BMWi, IGF no. 16662 N) and the "Forschungsvereinigung Antriebstechnik e.V. (FVA)". The results presented in this publication were taken from the FVA research project 293 III "Späte Zahnfußbrüche/ Reinheitsgrad" (Ref. 46). More detailed information on the influence of nonmetallic inclusions is given in the final report.

The underlying research work (Ref. 47) was funded in equal proportions by the "Forschungsvereinigung der Arbeitsgemeinschaft der Eisen und Metall verarbeitenden Industrie e.V. (AVIF)" (A 305 / S 0024/10235/16) and the "Forschungsvereinigung Antriebstechnik e.V. (FVA)". The results presented in this publication were taken from the FVA research project 293 IV "Späte Zahnfußbrüche/ Reinheitsgrad II" (Ref. 47). More detailed information on the influence of nonmetallic inclusions, especially in the very high cycle range, is given in the final report.

References

1. ANSI/AGMA 2001-D04:2004-12. *Fundamental Rating Factors and Calculation Methods for Involute Spur and Helical Gear Teeth.*
2. ISO 6336. *Calculation of Load Capacity of Spur and Helical Gears — Part 1–5.*
3. Nishijima, S. u. Kanazawa, K. “Stepwise SN curve and fish-eye failure in gigacycle fatigue.” *Fatigue Fracture of Engineering Materials and Structures* 22 (1999) 7, S. 601–607. doi: 10.1046/j.1460-2695.1999.00206.x.
4. Toyoda, T., Kaazawa, T. u. Hisamatus, S. “Influence of inclusions on the fatigue strength of shot peened carburized steel.” *Conf Proc: ICSP-5* (1993), S. 333–340.
5. Bathias, C., Drouillac, L. u. Le François, P. “How and why the fatigue S–N curve does not approach a horizontal asymptote.” *International Journal of Fatigue* 23 (2001), S. 143–151. doi: 10.1016/S0142-1123(01)00123-2.
6. Nakajima, M., Kamiya, N., Itoga, H., Tokaji, K. u. Ko, H. “Experimental estimation of crack initiation lives and fatigue limit in subsurface fracture of a high carbon chromium steel.” *International Journal of Fatigue* 28 (2006) 11, S. 1540–1546. doi: 10.1016/j.ijfatigue.2005.05.017.
7. Thumser, R., Kleemann, S., Bergmann, J. W. u. Kleemann, A. “Investigation on defect distribution and its statistical evaluation for case hardened material states.” *International Journal of Fatigue* 41 (2012), S. 52–56. doi: 10.1016/j.ijfatigue.2012.01.024.
8. Sun, C., Lei, Z., Xie, J. u. Hong, Y. “Effects of inclusion size and stress ratio on fatigue strength for high-strength steels with fish-eye mode failure.” *International Journal of Fatigue* 48 (2013), S. 19–27. doi: 10.1016/j.ijfatigue.2012.12.004.
9. Tridello, A., Paolino, D. S., Chiandussi, G. u. Rossetto, M. “VHCF strength decrement in large H13 steel specimens subjected to ESR process.” *Procedia Structural Integrity* 2 (2016), S. 1117–1124. doi: 10.1016/j.prostr.2016.06.143.
10. Tridello, A., Paolino, D. S., Chiandussi, G. u. Rossetto, M. “Ultrasonic VHCF tests on AISI H13 steel with two different inclusion content: Assessment of size effects with gaussian specimens.” *Procedia Engineering* (2015) 109, S. 121–127. doi: 10.1016/j.proeng.2015.06.218.
11. Tridello, A., Fiochetti, J., Biffi, C. A., Chiandussi, G., Rossetto, M., Tuissi, A. u. Paolino, D. S. “VHCF response of heat-treated SLM Ti6Al4V Gaussian specimens with large loaded volume.” *Procedia Structural Integrity* 18 (2019), S. 314–321. doi: 10.1016/j.prostr.2019.08.171.
12. Sandaiji, Y. u. Tamura, E. “Influence of loading type on fracture behaviour of high strength steel under very high cycle fatigue.” In: Zimmermann, M. u. Christ, H.-J. (Hrsg.): *VHCF7. Seventh International Conference on Very High Cycle Fatigue*: July 3–5, 2017, Dresden, Germany. Siegener Werkstoffkundliche Berichte, 14/2017. Siegen: Siegener Werkstoffkundliche Berichte 2017, S. 25–30.
13. Nambu, K. u. Egami, N. “Influence of hybrid surface modification on very high cycle fatigue strength of various steel materials.” In: Zimmermann, M. u. Christ, H.-J. (Hrsg.): *VHCF7. Seventh International Conference on Very High Cycle Fatigue*: July 3–5, 2017, Dresden, Germany. Siegener Werkstoffkundliche Berichte, 14/2017. Siegen: Siegener Werkstoffkundliche Berichte 2017, S. 302–307.
14. Wang, Q., Bathias, C., Kawagoishi N. u. Chen Q. “Effect of inclusion on subsurface crack initiation and gigacycle fatigue strength.” *International Journal of Fatigue* 24 (2002) 12, S. 1269–1274. doi: 10.1016/S0142-1123(02)00037-3.
15. Talerico, T. F. u. Cameron, Z. A. *Ultrasonic Gear Steel Fatigue* at NASA. Anaheim, CA 2019.
16. Zhao, A., Xie, J., Sun, C., Lei, Z. u. Hong, Y. “Effects of strength level and loading frequency on very-high-cycle fatigue behavior for a bearing steel.” *International Journal of Fatigue* 38 (2012), S. 46–56. doi: 10.1016/j.ijfatigue.2011.11.014.
17. Zhang, J. W., Lu, L. T., Shiozawa, K., Zhou, W. N. u. Zhang, W. H. “Effect of nitrocarburizing and post-oxidation on fatigue behavior of 35CrMo alloy steel in very high cycle fatigue regime.” *International Journal of Fatigue* 33 (2011) 7, S. 880–886. doi: 10.1016/j.ijfatigue.2011.01.016.
18. Zammit A., Mhaede M., Grech M., Abela S. u. Wagner L. “Influence of shot peening on the fatigue life of Cu–Ni austempered ductile iron.” *Materials Science and Engineering: A* (2012) 545, S. 78–85. doi: 10.1016/j.msea.2012.02.092.
19. Torabian, N., Favier, V., Dirrenberger, J., Adamski, F., Ziaei-Rad, S. u. Ranc, N. “Investigation of the response of dual-phase steels submitted to 20KHz and low frequency fatigue loadings.” In: Zimmermann, M. u. Christ, H.-J. (Hrsg.): *VHCF7. Seventh International Conference on Very High Cycle Fatigue*: July 3–5, 2017, Dresden, Germany. Siegener Werkstoffkundliche Berichte, 14/2017. Siegen: Siegener Werkstoffkundliche Berichte 2017, S. 368–373.
20. Zhu, M.-L., Xuan, F.-Z., Du, Y.-N. u. Tu, S.-T. “Very high cycle fatigue behavior of a low strength welded joint at moderate temperature.” *International Journal of Fatigue* 40 (2012), S. 74–83. doi: 10.1016/j.ijfatigue.2012.01.014.
21. Murakami, Y., Yokoyama, N. N. u. Nagata, J. “Mechanism of fatigue failure in ultralong life regime.” *Fatigue Fracture of Engineering Materials and Structures* 25 (2002) 8–9, S. 735–746. doi: 10.1046/j.1460-2695.2002.00576.x.
22. Murakami, Y., Nomoto, T. u. Ueda, T. “Factors influencing the mechanism of superlong fatigue failure in steels.” *Fatigue Fracture of Engineering Materials and Structures* 22 (1999) 7, S. 581–590. doi: 10.1046/j.1460-2695.1999.00187.x.
23. Mughrabi, H. “On the life controlling microstructural fatigue mechanisms in ductile metals and alloys in the gigacycle regime.” *Fatigue Fracture of Engineering Materials and Structures* 22 (1999) 7, S. 633–641. doi: 10.1046/j.1460-2695.1999.00186.x.
24. Mughrabi, H. “On ‘multi-stage’ fatigue life diagrams and the relevant life-controlling mechanisms in ultra high-cycle fatigue.” *Fatigue Fracture of Engineering Materials and Structures* 25 (2002) 8–9, S. 755–764. doi: 10.1046/j.1460-2695.2002.00550.x.
25. Bathias, C. “Fatigue Limit.” In: Wang, Q. J. u. Chung, Y.-W. (Hrsg.): *Encyclopedia of Tribology*. Boston, MA: Springer US 2013, S. 1041–1052.
26. Bretl, N. T. “Einflüsse auf die Zahnfußtragfähigkeit einsatzgehärteter Zahnräder im Bereich hoher Lastspielzahlen [eng.: influences on the tooth root load carrying capacity of case-hardened gears in the range of high load cycles].” Technical University of Munich Dissertation. Munich 2010.
27. Stenico, A. “Werkstoffmechanische Untersuchungen zur Zahnfußtragfähigkeit einsatzgehärteter Zahnräder [eng.: material-mechanical investigations of the tooth root load carrying capacity of case-hardened gears].” Technical University of Munich Dissertation. Munich 2007.
28. Stenico, A., Krug, T., Oster, P., Lang, K.-H., Höhn, B.-R. u. Löhne, D. “Eigenspannungen Zahnfuß. Eigenspannungseinfluss auf die Zahnfußtragfähigkeit kleinmoduliger Zahnräder,” FVA 369 I+II. FVA-Heft Nr. 745, Frankfurt a. M. 2004.
29. Bretl, N. T., Tobie, T. u. Höhn, B.-R. “Einflüsse auf die Zahnfußtragfähigkeit einsatzgehärteter Zahnräder im Bereich hoher Lastspielzahlen [eng.: Influences on the tooth root load carrying capacity of case-hardened gears in the range of high load cycles].” FVA project 293 II. FVA issue 851 Nr. 851, Frankfurt on the Main, Germany 2008.
30. Bretl N., Schurer, S., Tobie, T., Stahl, K. u. Höhn, B.-R. “Investigations on Tooth Root Bending Strength of Case Hardened Gears in the Range of High Cycle Fatigue.” AGMA Technical Paper 13FTM09 (2013).
31. Schurer, S. “Einfluss nichtmetallischer Einschlüsse in hochreinen Werkstoffen auf die Zahnfußtragfähigkeit [eng.: influence of nonmetallic inclusions in ultra-clean materials on the tooth root load-carrying capacity].” Technical University of Munich Dissertation. Munich 2016.
32. Winkler, K. J., Schurer, S., Tobie, T. u. Stahl, K. “Investigations on the tooth root bending strength and the fatigue fracture characteristics of case-carburized and shot-peened gears of different sizes.” *Proceedings of the Institution of Mechanical Engineers, Part C: Journal of Mechanical Engineering Science* (2019). doi: 10.1177/09554406219841650.
33. Fuchs, D., Schurer, S., Tobie, T. u. Stahl, K. “On the determination of the bending fatigue strength in and above the very high cycle fatigue regime of shot-peened gears.” *Forschung im Ingenieurwesen* (2021). doi: 10.1007/s10010-021-00499-2.
34. Thoma, F., Otto, M. u. Höhn, B.-R. “RIKOR I - Erweiterung Ritzelkorrekturprogramm (RIKOR) zur Bestimmung der Lastverteilung von Stirnradgetrieben [eng.: RIKOR I - Extension of the pinion correction program (RIKOR) to determine the load distribution of the gears,” FVA 30 VI. FVA-Heft Nr. 914, Frankfurt a. M. 2009.
35. *DIN EN ISO 683-3:2019*. “Für eine Wärmebehandlung bestimmte Stähle, legierte Stähle und Automatenstähle - Teil 3: Einsatzstähle. Heat-treatable steels, alloy steels and free-cutting steels - Part 3: Case-hardening steels.”
36. *ISO 6336-5:2016*. “Calculation of load capacity of spur and helical gears - part 5: strength and quality of materials.”
37. *ISO 4967:2013*. “Steel - Determination of content of nonmetallic inclusions - Micrographic method using standard diagrams.”
38. *SEP 1571-2:2017-08*. “Bewertung von Einschlüssen in Edelmetallen auf Basis der Einschlussflächen - Teil 2: Verfahren K und M.”
39. H. Rettig. “Ermittlung von Zahnfußfestigkeit-Kennwerten auf Verspannungsprüfständen und Pulsatoren.” *Antriebstechnik* 26 (1987) 2, S. 51–55.
40. McPherson, D. R. u. Rao, S. B. “Methodology for Translating Single Tooth Bending Fatigue Data to be Comparable to Running Gear Data.” *Gear Technology* March/April 2008 (2008), S. 42–51.
41. Hück, M. *Ein verbessertes Verfahren für die Auswertung von Treppenstufenversuchen* (1983).
42. Hösel, T. u. Joachim, F. “Zahnflankenwälzfestigkeit unter Berücksichtigung der

- Ausfallwahrscheinlichkeit." *Antriebstechnik* 17 (1978) 12, S. 533–537.
43. Gesamtverband der deutschen Versicherungswirtschaft: Erneuerbare Energien 2017.
 44. HBM an HBK company: "Drehmomentmessung in Windenergieanlagen - heute so aktuell wie damals, 2021." www.hbm.com/de/3108/drehmomentmessung-in-windenergieanlagen/, abgerufen am: 02.09.2021.
 45. Industrie Magazin: Wiener Motorensymposium: Autos werden für 5.000 Betriebsstunden gebaut, 2020. <https://industriemagazin.at/a/wiener-motorensymposium-autos-werden-fuer-5000-betriebsstunden-gebaut>, abgerufen am: 02.09.2021.
 46. Schurer, S., Tobie, T. u. Stahl, K. "Tragfähigkeitsgewinn im Zahnfuß durch hochreine Stähle [eng.: load carrying capacity increase in the tooth root due to ultra-clean steels]," FVA research project 293 III. FVA issue 1148 Nr. 1148, Frankfurt on the Main, Germany 2015.
 47. Fuchs, D., Tobie, T. u. Stahl, K. "Untersuchungen zum Fehlstellenversagen an Zahnrädern und deren Einfluss auf die Zahnradtragfähigkeit [eng.: Investigations into the defect failure of gears and its influence on the gear load carrying capacity]," FVA research project 293 IV, Frankfurt on the Main, Germany 2021.

For Related Articles Search

shot peening

at www.geartechnology.com

Daniel Fuchs

studied (2011–2016) at: Ostbayerische Technische Hochschule Regensburg (OTH Regensburg), Germany. Since 2016 he has served as a research associate at the Institute of Machine Elements—Gear Research Centre (FZG) of the Technical University of Munich. Fuchs' expertise is in the influence of nonmetallic inclusions on the tooth root load carrying capacity of gears and the influence of coarse grain on the load carrying capacity of gears.



Dr.-Ing. Thomas Tobie

is head of the department "Load Carrying Capacity of Cylindrical Gears" at the Gear Research Center (FZG), Technical University of Munich. He is specialized in the fields of gear materials, heat treatment, gear lubricants, gear strength and gear testing with focus on all relevant gear failure modes like tooth root fracture, pitting, micro-pitting, scuffing and wear as well as subsurface initiated fatigue failures. Dr. Tobie an active member of several national and international working groups of DIN, ISO, IEC and CEC and author of numerous papers at scientific journals and conferences.



Prof. Dr.-Ing. Karsten Stahl

is full professor at the Institute for Machine Elements and director of Gear Research Center (FZG) at the Technical University Munich. FZG research focuses on experimental and analytical investigations of endurance, tribology, NVH, materials and fatigue life analysis on gears, transmission components and drive systems. Prof. Stahl is board member of several scientific associations, convener of DIN and ISO working groups, editor of several scientific journals, author of several hundred publications, and president of the International Conference on Gears.



Archeology Just Got Easy

Gear Technology is happy to report that every issue (1984 to present) is now available online at

www.

geartechnology
.com.

Need articles on software, gear grinding, plastics, or lubrication?

Put away your shovel...

They're simply a keyword away.

Drop by our website to uncover decades of peer-reviewed technical and back to basic articles

You don't need to be an archeologist to "excavate" the information that matters to you.

www.geartechnology.com/issues.

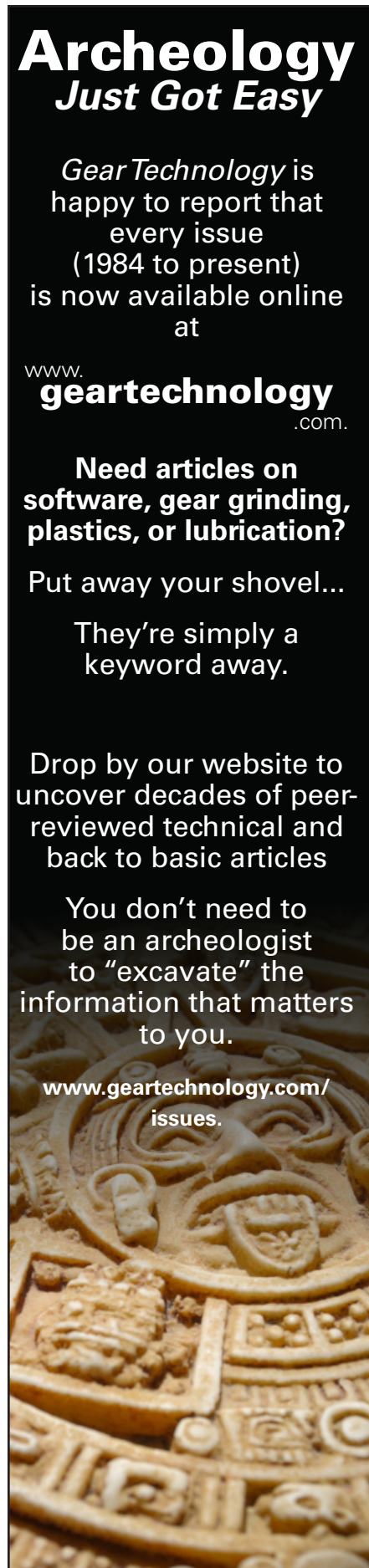

Klingelberg

REPORTS ON CONSTRUCTION PROJECT FOR NEW ASSEMBLY HALL

In December 2021, Klingelberg launched a construction project for a new assembly hall with connected logistics, thereby renewing its commitment to the traditional location of Hückeswagen in the Oberbergisches Land region (Germany). The new assembly hall will be designed for building large cylindrical gear machines, particularly for use in the wind energy industry.



Christoph Küster, chief financial officer of the Klingelberg Group, welcomed the positive development at the location. “I am extremely proud that we have such a longstanding tradition in Hückeswagen and are now expanding our operations in this way,” said the CFO. “With approx. 750 employees at two locations in Hückeswagen, Klingelberg is one of the largest employers in the region. It is therefore a positive sign for the city that we continue to see our future here.”

In December 2021, the groundwork was completed, and the preparations were made for the foundation. Assuming all goes

according to plan, the next steps call for the concrete columns to be installed in February 2022, followed by the roof trusses in April 2022. The traditional topping-out ceremony is scheduled for April/May 2022, depending on the weather conditions. To enable assembly of even the heaviest and most sensitive machinery, the halls will be fully air-conditioned and equipped with two bridge cranes — one with a 25-ton load capacity and one with a 40-ton capacity — and 10 wall-mounted traveling cranes with a 3.5-ton capacity. The hall will be built to meet the climate-efficiency requirements according to KfW 55 — a standard that

is not particularly common for industrial buildings at present. By implementing this efficiency standard, the energy demand and consequently the CO₂ emissions will be reduced. In addition, the plant technology was designed in such a way that currently 60 percent of the thermal energy is generated from renewable energies — an important step towards protecting the climate.

The new assembly hall, which will occupy a floor space of approximately 8,000 sq. meters including offices, will be home to over 100 employees in the future. The new site will also have its own employee cafeteria.

“We are planning to assemble the first machines there as early as fall/winter 2022,” Markus Friedrich, head of assembly and production at Klingelberg, is pleased to report. “The individual offices will then be occupied at the beginning of 2023. The project is very demanding and the schedule is tight. But we have every confidence that we will be able to implement everything on schedule.”

klingelberg.com

Star SU and Louis Bélet

ENTER INTO STRATEGIC PARTNERSHIP



Cutting tool and gear tool providers Star SU and Louis Bélet have entered into a strategic partnership to enhance each companies’ product portfolio and expand collective reach within the Americas and Europe.

“We believe this relationship will build great synergy between our companies and benefit our customers,” said David Goodfellow, president Star SU. “Although our product offerings are similar, this agreement enables us to provide even more innovative solutions in the micro mechanics field, where Louis Bélet is well-known.”

Added Roxane Piquerez and Arnaud Maître, Bélet co-CEO’s, “We look forward to strengthening our gear offering given Star SU’s strong presence and know-how within the field of gear cutting tools and machines, helping us expand our presence and better serve our customers.”

Louis Bélet is a family-owned company with over 70 years

in standard and customized tools based in Swiss Jura, the hub of micromechanics and high-quality precision. Bélet manufactures standard and custom precision cutting tools for various markets including watchmaking, medical, aerospace and automotive. Drills, end mills, thread and gear cutting tools including hobs or skiving tools for micro gears are among the standard and innovative solutions Louis Bélet provides to the market.

Star SU LLC offers a wide variety of machinery, precision cutting tools, and services including vertical gear hobbing machines and chamfering and deburring machines; gear hobs and milling cutters; gear Scudding and power skiving tools, gear shaper cutters and shaving tools; chamfer and deburring tools; gundrills and reamers; form tools; face mills and boring tools; advanced tool coatings; and tool life cycle management services.

star-su.com

Inductoheat

CELEBRATES DOUGLASS BROWN'S CAREER

Douglass R. Brown, president of Inductoheat, will retire after 42 years in the induction heating industry. Brown's contributions to the Inductotherm Group include 14 years as president/COO of Inductoheat, two years as president of Alpha 1, and 15 years as group forging technology manager.

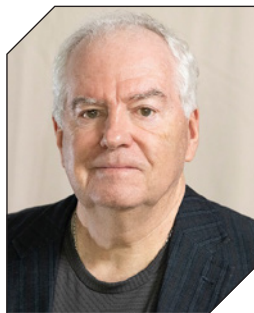

Brown holds a bachelor's degree in electrical engineering from Penn State, and an MBA from Kent State. He has multiple international patents in the field of induction heating for forging and was the founding chairman of the FIA (Forging Industry Association) Induction Heating School. He served on both the FIERF (Forging Industry Educational and Research Foundation) and FIA boards throughout his career.

inductoheat.com

Center for Powder Metal Technology

APPOINTS NEW PRESIDENT

Thomas Pfingstler, Atlas Pressed Metals, DuBois, Pennsylvania, has been appointed president of the Center for Powder Metallurgy Technology (CPMT), succeeding Arthur (Bud) Jones, Symmco, Inc. A longtime member of APMI International and the Metal Powder Industries (MPIF) Standards Committee, Pfingstler



Spiral Bevel Gears

- Spiral & straight bevel gear manufacturing.
- Commercial to aircraft quality gearing.
- Spur, helical, splined shafts, internal & external, shaved & ground gears.
- Spiral bevel grinding.
- Midwest Transmissions & Reducers.
- ISO compliant.



Midwest Gear & Tool, Inc.
15700 Common Rd., Roseville, MI 48066
Tel: 586.779.1300 mwgear@midwestgear.net



Unlocking the Vault

We've optimized more than 36 years of gear manufacturing articles with our enhanced search engine at

www.geartechnology.com

gear
TECHNOLOGY

received the MPIF Distinguished Service to Powder Metallurgy Award in 2019. He has a well-rounded understanding of the PM technology and unique view of part design, production, and business management, honed over his nearly 40-year career that includes management positions in various production, quality, engineering, and purchasing areas. He holds a bachelor of science degree in management from Clarion University.

The Center for Powder Metallurgy Technology, a recognized not-for-profit organization, was created in the early 1980s as an indirect result of a United States Department of Commerce effort to establish a series of “cooperative technology programs” involving several specific technologies. Each was selected by the government as being representative of “growth” technologies capable of enhancing the productivity of America’s manufacturing community.

cpmtweb.com

GF Machining Solutions

APPOINTS NEW PRESIDENT OF NORTH AMERICA

GF Machining Solutions has appointed **Chris Jones** as the company’s president and managing director of North America. Jones will expand GF’s presence in vital market segments, including medical, aerospace, automotive/die mold, packaging, energy and consumer electronics. Within these markets, GF Machining Solutions will continue to provide manufacturers with innovative application-specific technologies.



“My intent is to champion the customer and ensure that GF Machining Solutions is their most reliable and trusted manufacturing partner,” said Jones. “Leveraging my team’s expertise and deep understanding of the challenges today’s manufacturers face, we will work diligently to provide them with the quality and service they need for success.”

Jones brings to his new position over 25 years of manufacturing industry experience and a history of driving results in both the industrial automation and machine tool sectors. His professional skills include computer numerical control (CNC), complex robotic systems, sales management and Six Sigma.

gfms.com

Rego-Fix

ADDS TO TECHNICAL SUPPORT TEAM AND ACQUIRES GEWITEC

With the utmost technical support in mind, Rego-Fix has added **Mark Ohlfest** to the company’s OEM Technical Support team aimed at strengthening ongoing relationships with original equipment manufacturers (OEMs).



Ohlfest will work under Rego-Fix’s OEM Team Manager Bryan Bannister to help oversee all such business partnerships throughout

North America. In his new position, Ohlfest will also provide support, assistance, and collaboration with other members of the Rego-Fix global OEM team as needed.

“Our industry partners — machine tool builders and cutting tool manufacturers — rely on our products, and we offer these partners a specialized form of support as well as optimal tool-holding,” said Bannister. “With Mark as part of the OEM technical support team, we can further enrich these relationships and allow partners to ensure their customers receive the best possible service and support as well as the most advanced technology.”

With over 30 years of experience in manufacturing, Ohlfest



brings his expertise in CNC programming, mold design, applications engineering and account management to Rego-Fix. He has an extensive background in CNC programming, 2D and 3D CAM software, and high-speed three- and five-axis machining.

In addition, Rego-Fix AG has signed an agreement to acquire the majority equity interests of the Swiss based company Gewitec AG., an established, global provider of standardized precision parts for the tool and machine industry and for OEM solutions.

According to Richard Weber, CEO of Rego-Fix AG Switzerland, “Gewitec is an ideal fit for the Rego-Fix Group and working with them will offer increased opportunities and synergies between the two companies. Both share the same core values in terms of quality, customer service and Swiss made precision.”

Gewitec is headquartered in Kappelen, Canton of Berne, Switzerland. The company, its brands and management will remain unchanged. The core values and identity of Gewitec will continue unchanged as part of the Rego-Fix group.

us.rego-fix.com

Kuka Robotics

PLAYS KEY ROLE IN UNIVERSITY OF MICHIGAN RESEARCH GRANT

As part of a \$2 million National Science Foundation Grant, robots from Kuka Robotics are helping the University of Michigan (U of M) advance research that could result in robots working side-by-side with humans on building construction sites. The research involves three KUKA KR Quantec robots along with the company's robot sensor interface (RSI) software, all of which will allow human

Kuka's KR Quantec line of robots applies to a wide range of applications and provide high performance, cost-effectiveness, and flexibility. Such an expansive robot portfolio also offers U of M the capability to upgrade payloads in the field as well as apply software add-ons to adapt to changing applications.

What makes the construction application a challenge is the unstructured and changing environment in which the robots will work. In addition to the Kuka robotics, other automation technology that will help U of M overcome this challenge and make its research goals a reality includes various automation software packages, sensors, point cloud scanners, tool mounted laser scanners and vision systems. The sensors and scanners ensure complete safety in the construction environments where humans will be present, but not working in extreme proximity of the robots per se. However, if an individual does approach, the robots will slow their speed until it is safe to resume a normal work pace levels once that person is clear of the area.

The NSF Grant was awarded to an interdisciplinary team and encompasses the collaboration of U of M between the Taubman College of Architecture and Urban Planning and the College of Engineering as well as external research partnerships with the University of Florida and Washington State University. The U of M research team includes Wes McGee, an associate professor of architecture and director of Taubman College's preeminent fabrication and robotics lab (FABLab); Carol Menassa (team lead), an associate professor of civil and environmental engineering; Vineet Kamat, a professor of civil and environmental engineering and electrical engineering and computer science; Joyce Chai, a professor of electrical engineering and computer science; Honglak Lee, an associate professor of electrical engineering and computer science; Arash Adel, an assistant professor of architecture; X. Jessie Yang, an assistant professor of industrial and operations engineering; and Curt Wolf, the managing director of the U of M urban collaboratory.



workers to use interactive task learning technology to teach the robots to perform construction tasks.

The resulting symbiotic human-robot teams could then be widely deployed in the construction industry. The future human construction worker would then be responsible for high-level work planning and would transition to the role of robot programmer and supervisor. The robot would perform physically strenuous tasks and collaborate with the human supervisor to improvise when unforeseen work conditions are encountered.

The three Quantec Kuka robot models used across two labs at U of M are the KR 120, KR 60 and KR 6. For the research, the KR 120 is mounted on an external gantry while the KR 60 is on essentially a mobile hydraulic excavator platform. The KR 120 would be used for factory prefab/pre-manufacturing of construction assemblies, and the KR 60 would be the robot that would travel to job sites.

kuka.com

Jergens

APPOINTS NATIONAL SALES MANAGER FOR WORKHOLDING

Jergens brings on **Joseph Farkas** as national sales manager for its workholding solutions group as Ken Marvar looks to retire. Farkas comes to Jergens with more than 20 years of experience in sales development and management, as well as market channel strategies, for companies including The Timken Company, Fuchs, Sandvik and Kennametal.



“Joe has proven himself in his career with impressive results for some of industry’s top suppliers and I am confident that he will also do a great job and take WSG to the next level,” said Marvar. Farkas is Six Sigma trained and has a strong background in business planning, P&L performance, sales and customer service metrics, and technical training. Farkas holds an associate degree in mechanical engineering from Stark State College, has a bachelor’s in business management from Malone University, and an MBA from Ashland University. He lives in the Akron, OH, area with his wife Mandy and daughter Savannah.

jergensinc.com

Sandvik Coromant

APPOINTS HEAD OF SUSTAINABLE BUSINESS

Camilla Nevstad Bruzelius, currently deputy head of the global agenda department at the Swedish Ministry for Foreign Affairs, has been appointed head of sustainable business at Sandvik Coromant.



She will create and drive the Sandvik Coromant Sustainable Business Program, which includes developing, influencing and delivering the organization’s sustainability strategy.

Another key responsibility will be to support heads of business functions and leaders within the organization to deliver a better-integrated sustainability strategy and demonstrate progress against set sustainable business objectives. Bruzelius will also engage in communication and marketing of sustainable business campaigns to internal and external stakeholders.

She holds a Master of Laws (LL.M.) in International Law from Lund University. She has 20 years of experience from various positions within the Ministry for Foreign Affairs, most recently as deputy head of the Global Agenda Department. Bruzelius has also served as head of the Sustainability Group at the Swedish Permanent Mission to the United Nations in

New York and chief of staff to the Minister for International Development Cooperation and Climate.

sandvik.coromant.com

C & B Machinery

ANNOUNCES PARTNERSHIP WITH PTG – HOLROYD

C & B Machinery recently announced a new partnership as the exclusive North American agent for PTG – Holroyd. The agreement was finalized late last year and is now in full swing with multiple active projects in the final stages of the RFQ process.

“From our initial introduction to PTG – Holroyd’s technology, their company history, and the teams’ expertise we knew that this would be a great partnership,” said C & B Machinery’s Vice President of Sales Fabrizio Tarara. “With the rapidly changing marketplace due to electrification, we have received many inquiries from our customer base asking C&B to offer more solutions. Our customers are looking to give work to trusted partners with a proven track record of delivering robust turn-key systems. We see this as a perfect match for the future with an immediate positive response from our existing customer base!”

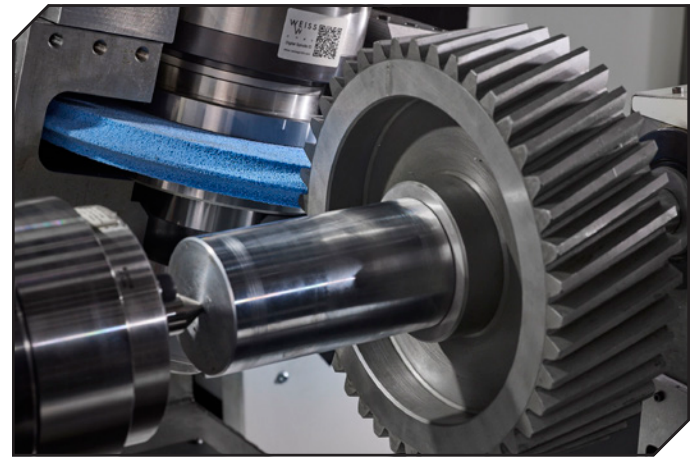

“With significant experience supplying and manufacturing precision machines, and recognized for providing high levels of customer service, C & B Machinery was able to demonstrate the uncompromising standards we expect from our agents,” PTG-Holroyd Sales Director, Mark Curran, said.

“C & B Machinery will offer our full range of rotor milling machines, rotor grinding machines, gear grinding machines, screw pump and worm gear grinding machines, as well as PTG Powerstir friction stir welding (FSW) machines for transport applications,” he added.

cbmachinery.com

May 17–19—Fundamentals of Parallel Axis Gear Manufacturing

The three-day seminar (Elgin, Illinois), formally titled “Fundamentals of Parallel Axis Gear Manufacturing,” offers gear manufacturing personnel of all levels an ideal, cost-effective review of the basics of gear production. Anyone new to the industry, including manufacturing management, engineers, supervisors, set-up technicians, operators, and quality control, will benefit from the course’s thorough overview of parallel axis gear manufacturing topics. A team of engineers from Helios Gear Products and Kapp Technologies will teach the 2022 school, ensuring attendees access a wealth of expertise. Topics of the school include gear nomenclature (“how to speak gearing”), hobbing, shaping, power skiving, generating grinding, form grinding, inspection (AGMA and DIN standards), cutting tools, fixturing, blanks, production estimating, troubleshooting, and more. Attendees will find the school offers an invaluable overview of gear manufacturing technology, methods, challenges, and trends.

heliosgearproducts.com



May 17–19—GrindingHub 2022

GrindingHub (Stuttgart, Germany) offers the latest solutions in grinding technology and superfinishing. The trade fair’s focus includes grinding machines, tool grinding machines, abrasives, software tools and measuring and testing systems. Before and after the trade show, GrindingHub offers hybrid events including digital formats for matchmaking, web seminars, conferences as well as the communication of current trends and innovations across all channels. The “Grinding Solution Park” focuses on the latest industrial and scientific solutions while the “Start-Up Area” strengthens young grinding companies. “Today, modern exhibition concepts must take the additional step into the web world and provide online content that helps exhibitors to extend their international reach and awareness,” said Wilfried Schäfer, managing director of the VDW.

grindinghub.de/en

May 18–19—CTI Symposium USA

The CTI Symposium USA (Novi, Michigan) will update attendees on the latest technical developments and applications on automotive transmissions for conventional and alternative drives. Exchange experiences, discuss technologies and strategies with automotive experts from USA, Asia and Europe. The conference and exhibition provide expert-led plenary and technology sessions as well as expert discussions and product showcases representing the full range from complete drivetrain systems to components and engineering services.

drivetrain-symposium.world/us/



May 30–June 2—Hannover Messe 2022

Hannover Messe 2022 (Hannover, Germany) focuses on industrial transformation, which is driven by two megatrends: digitalization of industry and a reduction of CO2 emissions. Digitization covers topics such as networking, data analytics, the Internet of Things, platforms, artificial intelligence and IT security. Companies that want to remain globally competitive must take advantage of digitalization to develop, manufacture and sell products faster and more efficiently. In Hannover, companies from the electrical engineering, mechanical and plant engineering, software and IT sectors will be demonstrating how the automation and digitalization of entire production and business processes can succeed. Innovative solutions enable industry to react responsibly to growing political and social debates about environmental protection. At Hannover Messe, companies from the energy sector, among others, will be presenting how industrial companies can significantly reduce their energy consumption and CO2 emissions. With these future technologies, industry makes a significant contribution to reaching national and international climate goals. hannovermesse.de/en

May 31–June 2—Eurotrans Gear Week 2022

Eurotrans Gear Training will be held online with live online presentations by top industry experts—three weeks packed with specialized gear design training. This comprehensive online course has been developed by Eurotrans, the European Committee for Power Transmission Engineering, in cooperation with FVA Software & Service, and leading gear experts from Germany. This course is oriented to people active in the gears sector with a basic engineering background and provides improvement of knowledge on geometry and design aspects of gears and gear systems. Further, this course is given in English and contributes to improve the language skills of the participants by interacting with the experts and with their peers from other countries.

fva-service.de/en/

AFC Holcroft – Page 17
afc-holcroft.com

Atlas Bronze – Page 7
atlasbronze.com

B&R Machine and Gear Corp. – Page 27
brgear.com

Cattini North America – Page 38
cattiniNA.com

Cramlington Precision Forge – Page 39
cpfl-tvs.com

DTR Corp. – Page 29
dragon.co.kr

DVS Group – Page 3
dvs-technology.com

Forest City Gear – Page 11
forestcitygear.com

Gear Research Institute – Page 38
gearresearch.org

Gleason Corporation – Inside Back Cover
gleason.com

Goldstein Gear Machinery – Page 22
goldsteingearmachinery.com

Hobsource – Page 39
hobsource.com

IMTS – Page 19
IMTS.com

Involute Gear & Machine – Page 18
involutegearmachine.com

Klingelberg – Outside Back Cover
klingelberg.com

Liebherr – Page 15
liebherr.com

Machine Tool Builders – Page 5
machinetoolbuilders.com

McInnes Rolled Rings – Page 22
mcinnesrolledrings.com

Midwest Gear & Tool – Page Cover, 57
mwgear@midwestgear.net

Nidec Machine Tool America – Page 9
nidec-machinetoolamerica.com

Nordex Inc. – Page 39
nordex.com

Penta Gear Metrology – Page 39
gearinspection.com

Precision Drive Systems – Page 38
SpindleRepair.com

Proto Manufacturing – Page 21
protoxd.com

SMT – Page 16
smartmt.com/masta

Solar Atmospheres – Page 4
solaratm.com

Southern Gear & Machine – Page 14
southerngear.com

Spiroid Gearing – Page 35
Spiroidgearing.com

Star SU LLC – IFC-Page 1, Page 38
star-su.com

Surface Combustion – Page 35
surfacecombustion.com

Texas A&M Turbomachinery Show – Page 13
tps.tamu.edu

EXCELLENT GEAR MACHINERY FOR SALE

Gleason Model 17A Hypoid Tester, 20" Gear Diameter, #39 & #14 Tapers, Hydraulic Clamping, Gearhead ID = 0.0008" (0.02 mm). Face = 0.0002" (0.0050 mm); Pinion ID = 0.0003" (0.0075 mm). Face = 0.0001" (0.0025 mm)

Gleason Model 519 Universal Tester, 36" Gear Diameter, 12" Pinion, #60 & #39 Tapers, ID Both Spindles = 0.00005" (0.00127 mm). Speeds 200 to 2000 rpm, 1967

Klingelberg Model AH1200 (48") Bevel Gear Quenching Press including Manipulator, Furnace & Dies Seen Minimum Usage Built 2008

GEAR TOOLING

GLEASON Model 104 Coniflex Cutter Bodies & Blades

GLEASON Model 605-610 Index Plates, Lift & Drop Cams

GLEASON 6" & 9" HARDAC Cutter Bodies

GLEASON Model 645, Model 2/102 & Model 17 Generating Cams

GLEASON Model 109 Lift & Drop Cams

GLEASON Model 19 Index Plates

GLEASON Model 112 Lift & Drop Cams

GLEASON 40- & 45-Degree Dresser Blocks

BARBER COLMAN Model 10-12 Sharpener Index Plates

KAPP AS305 (AS305B, AST305) Index Plates & Masks

REISHAUER Wheel Mounts

michael@GoldsteinGearMachinery.com

GET 56 YEARS OF EXPERIENCE AND KNOWLEDGE WORKING FOR YOU



www.gearmachineryexchange.com

RESPONSE REQUIRED

YES I want to receive/continue to receive *Gear Technology*

NO Thanks anyway, but I don't need the world's best publication on gear engineering and manufacturing.

Name _____ Job Title _____
(please print)

Signature _____ Date _____
(required)

How would you like to receive *Gear Technology*?

- PRINT version (Verify mailing info below)
- DIGITAL Version (E-mail required)
- BOTH Print AND Digital (E-mail required)

E-mail _____ *

How are you involved with GEARS?

- My company MAKES GEARS (20)
- My company BUYS GEARS (22)
- I DESIGN gears (23)
- I am a SUPPLIER to the GEAR INDUSTRY (24)
- OTHER (Please describe) _____

What is your company's principal product or service? _____

***Your PRIVACY is important to us. You get to CHOOSE how we use your personal information. The next e-mail we send you will have clear instructions.**

MAILING INFORMATION

NAME:

JOB TITLE:

COMPANY:

ADDRESS:

- Check if this is a home address

CITY:

STATE/Province:

ZIP/Postal Code:

PHONE:

FAX:

Put your business card here to make it easier!



Mail to:
1840 Jarvis Ave., Elk Grove Village, IL 60007 USA

or

FAX to 1-847-437-6618
SCAN to: subscribe@geartechnology.com

Light, Movement, Perspective, LEGO!

Why Every Gear Geek Should Visit “The Art of the Brick”

Matthew Jaster, Senior Editor

The Art of the Brick (AOTB) is a LEGO exhibition combining art, science and innovation to inspire visitors of all ages currently on display at the Museum of Science and Industry (MSI) in Chicago.

“At their core, art and science are both about observation, exploration, and creativity. At MSI, we believe wonder and awe lives at the intersection of art and science and welcome the opportunities to open that thinking to guests,” said Anne Rashford, director, features experiences, public programs and business development at MSI.

LEGO, of course, has introduced many *Gear Technology* readers to the wonderful world of engineering, manufacturing and art. This latest exhibition features more than 100 incredible works of art made from millions of LEGO bricks.

Rashford sees the exhibition as a perfect example of STEAM learning—where innovators have carefully placed ‘the Arts’ in between Science, Technology, Engineering and Mathematic skills.

“What we see in AOTB is the coming together of both STEM, and the Arts—which creates an opportunity for people to see the direct connections between the two in a form that resonates with them. It’s a great example of how STEAM helps spark creativity through the arts while showing a parallel with STEM learning,” Rashford said.

Outside of receiving a crash course in LEGO innovation, visitors walk away with a better appreciation on how to work through real life problems by offering a creative environment to drum up solutions.

Rashford believes any student interested in science, engineering and manufacturing would gain valuable insight walking through AOTB.

“The more exposure students get to STEM related activities, content, or opportunities, the more likely they are to be confident in pursuing the field as a career. When you can show how STEM and Arts can collide, it allows them to see the variety of ways the two can coexist and complement each other,” Rashford said.

She’s not surprised by the initial success of the exhibition. In the past, MSI developed an exhibition with LEGO Master Adam Reed Tucker, called Brick by Brick.

“Adam was an architect and the focus of his work and the exhibit was on architecture, design and engineering. The exhibit was so popular we extended it three times. What



Nathan Sawaya works on a LEGO sculpture for The Art of the Brick exhibition.

surprised me most was that the audience was multigenerational—LEGO is timeless and its appeal is universal, just like AOTB,” Rashford added.

Behind the scenes, MSI is engaged in a variety of programs to support STEM education. The museum’s nationally recognized education programs, the “Welcome to Science Initiative,” were created to inspire and motivate children to achieve their full potential in the fields of science, technology, medicine and engineering.

“The ‘Welcome to Science Initiative’ creates learning experiences both inside and outside the classroom and removes barriers that exclude youth from participating. Providing access is critical—MSI places a priority on serving schools and neighborhoods with predominantly low-income student populations and reaching youth who are underrepresented in STEM fields,” Rashford said.

Contemporary artist Nathan Sawaya is the ‘master builder’ behind the AOTB exhibition. It’s the first major museum exhibition to use LEGO bricks as the sole art medium.

LEGO versions of Van Gogh’s “Starry Night” and Da Vinci’s “Mona Lisa” are fan favorites but Rashford prefers the Chicago-specific sculptures Sawaya incorporated such as Fly Boy (hebrubrantley.com), MSI’s creation of One Brick Studio (an interactive LEGO build experience) and Pernicieum (perniciemcollection.com). 

AOTB runs through September 5, 2022, at MSI in Chicago.

msichicago.org/visit/tickets



nano.

Inspection at Nano Level

The new GMS nano series combines latest inspection capabilities into a single, compact platform for the complete inspection of gears and shafts, fine pitch gears as small as .2 module. Measure sub-micron surface finish with a skidless probe, analyze waviness for profile, lead and pitch, execute noise analysis with sophisticated software tools.

gleason.com/nano



Total Gear Solutions

Gleason

R 300 THE GEAR NOISE FINDER

MAXIMUM PRODUCTIVITY FOR QUIET GEARS

HIGH-PRECISION TESTING FOR ALL FIVE ROLL TESTING METHODS



KLINGELBERG



Subject to changes

Due to the increasing quality requirements in large-scale transmission manufacturing, some transmission and vehicle manufacturers now require a certificate of quality for all gears installed in the powertrain. A further driver of ever-higher inspection levels is e-mobility, which places much higher demands on the noise behavior of a transmission due to the elimination of the combustion engine. To meet this challenge, Klingelberg has developed the Höfler Cylindrical Gear Roll Testing Machine R 300. As an ideal addition to the Höfler Speed Viper Generating Gear Grinding Machines, the R 300 covers all five roll testing methods in one compact machine. The perfect solution for anyone who wants to combine inspection cycles and reduce disassembly costs while benefiting from a user-friendly design.



Learn more:

BEVEL GEAR TECHNOLOGY | CYLINDRICAL GEAR TECHNOLOGY | PRECISION MEASURING CENTERS | DRIVE TECHNOLOGY

WWW.KLINGELBERG.COM